

1 | 12

An ABB technical journal
for Enclosures and
DIN rail Products users

Day ^{by} DIN



News and curiosities for informed professionals

IEC 61439

The new standard for low-voltage switchgear and controlgear ASSEMBLIES

SMISLINE TP – Power and safety

ABB solution for touch-proof pluggable socket-systems

A real success story: started in 1891 and patented in 1924

Hugo Stotz launched the first MCB onto the market in 1928

Power and productivity
for a better world™



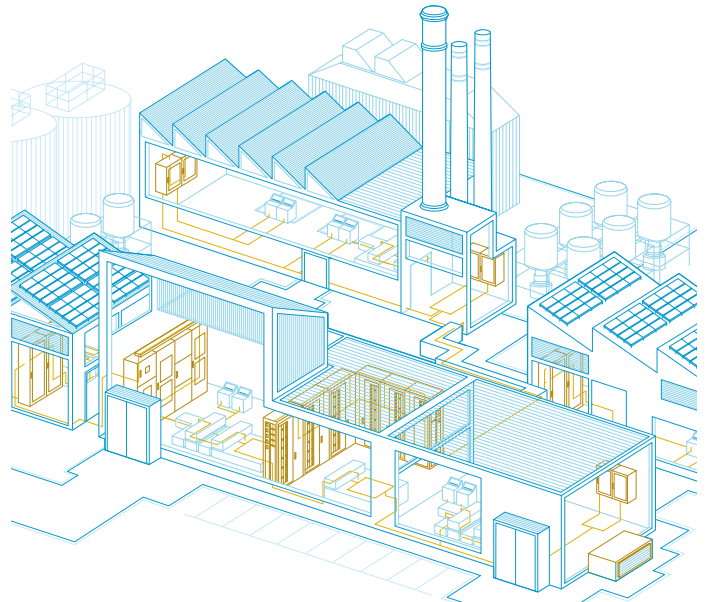

04 **Jump in the box**

A guide to DIN products: what's new

26 **IEC 61439**

The new standard for low-voltage switchgear and controlgear ASSEMBLIES

Day by DIN 1|12



Emanuele Tosatti
Product Marketing Manager
DIN Rail Products
ABB

Welcome!
For this first issue of Day by DIN let me start with an introduction. Since many years ABB is working with passion and dedication to improve electricity reliability, safety and efficiency. Our cover page shows a milestone of electricity history: Stotz Kontakt Research and Development team, working in 1926 on most famous Hugo Stotz's invention, the miniature circuit breaker as we all know it now.

Professionals of electricity love ABB low voltage products' wide range, its quality, and its reliability. Even more they like to be informed about the latest trends, innovations and Standards in our business. The purpose of Day by DIN is to share with professionals of electricity

- installers and consultants, panel builders and wholesalers - product information and news, opinions, questions, curiosities, interesting facts and applications in electrical business, with the target to achieve together our professional growth, day by day...or better...Day by DIN!

Day by DIN is written by passionate ABB professionals who work every day with our Customers and is available in hardcopy printed on FSC certified paper, to ensure responsible management of forests. You can also download your copy in electronic format from <http://goo.gl/MW0nD>





54

**A real success story:
started in 1891 and
patented in 1924**

Hugo Stotz launched
the first MCB onto the
market in 1928

60

SMISLINE TP – Power and Safety

ABB solution for touch-proof pluggable socket-systems

News and facts

- 4 Jump in the box**
A guide to DIN products: what's new
- 12 In the news**
Literature on our latest products
- 18 Top five**
Market classification
- 19 Events**
ABB at the Light+Building 2012

The expert answers

- 20 Good morning DIN rail**
The editor responds
- 32 Energy saving ideas**
E250 latching relays
- 38 Doktor Wise**
The expert answers

Curiosity

- 48 A short look at the meaning of lightning
through the ages**
- 49 Electric power and modernity:
new scenarios, new possibilities**

Case History

- 40 Environmental sensitivity and energy saving**
Zero impact forwarding and logistics

Technical

- 22 Precision of energy metering**
Conforming to the MID Directive
- 26 IEC 61439**
The new standard for low-voltage switchgear and
controlgear ASSEMBLIES
- 34 Urban legends**
Exploding the myths and reconsidering convictions
- 46 A world without electricity**
An imaginative picture to think of the future
- 50 Continuity of supply**
ABB APR high-immunity residual current devices
offer excellent protection against unwanted tripping
- 58 Surge and lightning protection standard IEC /
EN 62305 -1/ -2/ -3/ -4:2010**
- 60 SMISLINE TP – Power and safety**
ABB solution for touch-proof pluggable
socket-systems

Report

- 54 A real success story: Started in 1891 and
patented in 1924**
Hugo Stotz launched the first MCB onto the
market in 1928

Time to relax

- 64 Connect the boxes**
- 66 Wall of fame**

Jump in the box

ABB's newest products and solutions from Enclosures and DIN Rail Products world! In this issue new miniature circuit breakers, line protection devices, medical location solutions, new measuring devices and more.

Protection

MCB S 200 / S 200 M

Uncompromising safety and comfort

The revolution started in 1923 with the first miniature circuit breaker, patented by Hugo Stotz. Back then and still today we are a trendsetting pioneer and technical leader for easy, safe and reliable use of electricity. Our circuit breakers S 200 and S 200 M are a living proof. So, with the new colored real contact position indication, you can see the status within a twinkle of an eye. The optimized plane terminal plates guarantee right connection and can be reached even when the MCB is already installed. Even the best can still be optimized: more than 20 patents on this range of circuit breakers give you more benefits. Due to our long know-how, we are now using the first fully-automated testing machine world wide: highest quality, made by ABB. These and a lot more benefits make the miniature circuit breakers an effective addition to the successful System pro *M* compact®. Here you can find a wide range of compatible components for all your installation needs.

Brochure: 2CDC002026B0204



Benefits

- Patented tripping device: uncompromising safety
- Contact position indication: comfort and safety
- New and patented terminals for highest comfort, safety and flexibility
- Laser printing: scratch and solvent resistant marking
- Easy product coding – easy identification
- Environmental friendly
- High nominal voltage at constant performance
- Immediate system availability after fault removal – just a switch!
- Usability for uninstructed people

Protection

MCB S 200 MT

Keep on moving: availability and protection for railways



Benefits

- Product for the needs of the traction segment (shock and vibration)
- Fulfilling Exigence 3 requirements
- Fully compatible with the current System pro M compact accessories
- Removal of devices from the assembly
- Bi-directional cylinder-lift terminal
- Busbar fitted at rear terminal

ABB produces equipment and systems with the highest performances, as required by the particular conditions of use that are a characteristic of electric traction. And, still today, undergrounds, tramways and railways throughout the world use modern ABB technologies to guarantee their users a safe and high quality service.

ABB responds to this need with its new range S200MT, specially designed for undergrounds, tramways and railways.

The new product range is compatible with the current System pro M compact accessories, tested for shock and vibration, fulfills Exigence 3 requirements and combines the known benefits of the S200M range: bi-directional cylinder-lift terminal, removal of devices from the assembly without tools, busbar fitted at rear terminal, several characteristics, number of poles and 10 kA breaking capacity acc. to IEC 60898-1.

Catalogue: 2CDC002053D0203

Protection

MCB S 200 S

Easy, quick and safe: screwless terminal connection



Benefits

- Faster installation thanks to clever connection technology
- High flexibility by using rigid and flexible conductors
- Excellent visibility thanks to inclined position of terminals

The new ABB miniature circuit breakers of the S 200 S series can be integrated considerably faster and more easily due to a new, clever connection technology. The outgoing conductor is simply inserted into the terminal block, which already connects it firmly and safely to the circuit breaker. The wiring is released by a simple push on the newly developed release lever.

Connection possibilities:

- Rigid and flexible conductors with connector sleeves
- Flexible conductors without connector sleeves

Highest safety: The clamping force remains constant throughout the entire lifecycle.

Comfort and time saving:

- No tools are needed
- Separate opening to facilitate voltage testing in outgoing circuit.

The new MCBs of the S 200 S series are fully compatible with all components of the System pro M compact.

Technical data sheet: 2CDC002137D0201

Protection

S800-SCL-SR

The ideal solution for group protection

S800-SCL-SR is a self resetting current limiting module based on the S800 technology. It limits the short-circuit current until the downstream means of protection trips. Its current continuity makes it as the ideal solution for group protection: All parallel branches remain operative. This leads to an expanded application range of the low voltage switchgear whose short-circuit capabilities are usually limited.

Brochure: 2CCC413009B0201



Benefits

- Maximum system availability
- Compact design
- Cost saving solution
- Reliability
- Safety
- Flexibility

Metering

Electricity meters

Electricity meters for modular enclosures and DIN rail



Modular DIN Rail Products offer a wide range of functions to be integrated in electrical installations with significant benefits for the user. DIN rail mounted electricity meters are designed for high level performance and are safe and fast to install.

DIN rail mounted electricity meters are available in several models: the brand new EQ meters C11, ODINsingle and the brand new EQ meters A41 and A42 for single phase metering, ODIN and the brand new EQ meters A43 and A44 for three phase metering.

The meters are designed for use in sub-metering and are available in various configurations to suite many applications.

Catalogue: 2CMC480001C0201



Benefits

- Direct connected up to 80 A or transformer connected 1, 2 or 5 A
- Active or active and reactive energy
- Accuracy class C, B or A (Cl. 0.5, 1 or 2)
- Import or import and export measurement of energy
- Wide voltage range (100 – 500 V or 173 – 690 V)
- Pixel-oriented display
- Up to 4 tariffs
- Up to 4 inputs and outputs
- Optional clock functionality with tariff control, previous values, max demand, load profiles
- Harmonics measurement up to 16th harmonic and THD evaluation
- Pulse output, built-in communication, external communication adapter
- MID type approval “annex B”, MID initial verification “annex D”
- IEC type approval

Protection

QSO

Switchboards for operating rooms



The new QSO switchboards for operating rooms are the ideal solution for electrical distribution in group-2 medical locations, in conformity with the requirements of IEC 60364-7-710 regulations. They are available in four sizes - S, M, L and XL - each of which in two versions: PREMIUM and CLASSIC. Compactness, total protection selectivity and maximum ergonomics and simplicity during maintenance operations make the QSO range the most suitable product for ensuring operational continuity at medical locations. ABB also supplies the declarations required for commissioning of operating-room switchboard, ensuring the installer full conformity with technical regulations.

Brochure: 2CSC004033B0202



Benefits

- Wall-mounted switchboards complete with all equipment up to 8 IT-M circuits and 3 TN-S circuits
- Floor-standing switchboard with an even richer set of features to ensure modern hospitals maximum selectivity
- Total selectivity up to 10 kA thanks to S702 E sel main circuit breaker
- Greater attention to operational continuity and convenience across the whole product life cycle, above all for maintenance operations
- Possibility to manage the system's protection and monitoring functions remotely
- Transformers with PT100 probes installed on the whole range, in conformity with the most recent international regulations

Monitoring

ISOLTESTER MRM

Touch screen terminals for monitoring operating rooms



Thanks to ISOLTESTER-DIG-PLUS, CP415M touch screen terminals and AC500-eCo series PM554-T PLCs it is possible to control the status of a group of operating rooms (from 2 to 99) from one or two different stations. Personnel can verify the status of each operating room and any alarm signalling in real time.

ISOLTESTER MRM BOX includes the exclusive H+Line software in 5 languages, which allows a very simple system installation: no programming is necessary, indeed it is sufficient to insert the total number of operating rooms to be monitored on the touch screen panel.

Brochure: 2CSC004033B0202



Benefits

- A general Main menu, from which it is possible to see at a glance if the systems of each room are working properly or if anomalies or faults are present
- Alarms page which summarises metering in real-time, maxima and minima and any fault or malfunction alarms
- Languages setup page, allowing the interface language to be set up simply by touching the display. The following languages are available: Italian, English, German, Spanish and Portuguese
- Setup page where it is possible to enter the configuration parameters of the system and limit access to the panel using a password

Protection

QIT

Switchboards for data centres

QIT is the new ABB switchboard ideal for supplying and protecting data centres, server farms and data warehouses. QIT is the result of decades experience in critical applications such as medical locations. In these applications, maximum operational continuity is required, which can only be ensured by means of an insulated neutral IT network which allows normal operation even in the presence of a primary earth fault.

In addition, QIT includes all the most recent ABB devices which ensure maximum speed and efficiency during fault analysis and any subsequent component maintenance. QIT switchboards are RAL 7012 coloured for complete uniformity with ABB's range of industrial products.

Brochure: 2CSC004033B0202



Benefits

- ANR96-230 network analyser with advanced analysis functionality for LV and MV single-phase and three-phase distribution networks
- ISL-C 600 insulation monitoring device for alternating current IT networks up to 760 V
- Unifix L rapid wiring system for rapid replacement of equipment
- Alarm monitoring
- S700 E circuit breaker for total downstream selectivity up to 10 kA

Protection

E 90 PV fuseholders - UL listing

Photovoltaic fuseholders listed according to UL Standards for US Market



Underwriters Laboratories UL listed E 90 PV fuseholders for photovoltaics according to UL 4248-1. Furthermore E 90 PV fuseholders are USL listed according to Subject UL 4248-18, Outline of Investigation for Fuseholders - Part 18: Photovoltaic. The UL listing of E 90 PV enables United States installers and OEMs to take profit of outstanding E 90 PV performances into their photovoltaic installations. Furthermore E 90 fuseholders are an ideal solution for worldwide inverters and combiner boxes Manufacturers offering their solution in North American markets.

Brochure: 2CSC444002B0202



Benefits

- Fuse disconnectors according to IEC 60947-3, DC-20B
- Blown fuse indicator available for both one and two poles versions
- Blown fuse indicator works from 24V DC to 1000V DC
- High temperature performance and very low derating factor for battery installation

Measurement

ANR Network Analysers

Ease of choice, high measurement accuracy and many solutions for remote communication



Benefits

- Wider range of communication protocols, including Profibus and Ethernet
- Dot matrix display featuring real time waveshape and harmonic analysis
- Thanks to Ethernet, no additional network wirings requested
- Measurement, analysis, data logging, power management and energy efficiency made real, in a single device

ANR applications are widened thanks to the new versions ANR96...02 featuring 0,2% accuracy class on voltage and current. The new ANR96PRF, equipped with Profibus DP protocol, are the answer to the automation process industry needs. They ensure fast refresh rate and, through digital inputs, they allow management of information from many field devices on a single instrument. ANR96LAN, featuring Modbus TCP/IP protocol, use existing corporate Ethernet network infrastructure. They are the ideal solution to get all the benefits of remote communication without setting up new wirings. ANR144 and all auxiliary cards are now phasing out. New ANR96 range codes replace features of former ANR144 range.

Brochure: 2CSC445050B0201

Protection

EPD24-TB-101

The selective protection facilitates maintenance



Benefits

- In case of a short circuit, electronic limitation of the current prior to the opening of the circuit
- Disconnection in case of overcurrent from $1.1 \times I_n$ upwards, even with long load lines and small sections of cable
- Limitation of the active current for the safe connection of capacitive loads up to 20.000 μF
- Rated currents from 0,5A to 12A
- Manual control of the device
- LED for indication of the status of protection and signaling contact
- Reduced dimensions: only 12.5 mm width per line
- Busbars for multiple supply (LINE+ and 0V) and busbar for auxiliary contacts to monitor more EPD24 in battery
- UL and CSA approval

ABB proposes the range of electronic protective devices EPD24-TB-101 for the selective protection of the systems supplied at 24 V DC. In cases of overcurrents or short circuits, the line is identified and isolated preserving the operational continuity of the system. The remote contact and the LED allow the monitoring of the state of each line.

Technical catalogue: System pro M compact® 2011 edition 2CSC400002D0209

Command

E219 indicator lights

New 2- and 3-LED DIN rail indicator lights
Half the size for greater effect

The new ABB 2- and 3-LED indicator lights allow visualisation of ON and OFF status (such as in home electrical systems, commercial buildings or industrial panels), or visual monitoring of the presence of three-phase voltage in electrical distribution panels, simply, easily and in very small space (9 mm). The integrated 2-LED versions are available with red and green LEDs, and in two different voltage ranges: 115-250 VAC or AC 12-48. 115-250 VAC or 12-48 VAC. The E219 and E219-3C-3D models, with lights of the same colour, are available in green or red. The E219-CDE “traffic-light” version (red / orange / green), allows to display the status of circuit breakers, motor starters and more. The 3-LED version is available for a voltage of 415/230 VAC.

Brochure: 2CCC441002C0201



Benefits

- Touch protection according to DIN EN 50274 (DIN VDE0660 Section 514)
- Ease of use, safe connection
- LED voltage ranges:
 - E219-2CD48: 12-48 VAC / DC
 - E219-2CD: 115-250 VAC
 - E219-3C,3D,3CDE: 415/250 VAC
- Average LED life: approx. 100,000 hours
- Innovative design
- Reduced power consumption
- Conformity with International Standards

Protection

ELR: ABB range of front panel residual current relays

Protection device according to IEC/EN 60947-2 Annex M



Thanks to the residual current relays it is possible to measure the leakage current to earth. These relays work in conjunction with a separate external toroid. The new range of ELR products from ABB complies with IEC/EN 60947-2 Annex M and is tested within a configuration that includes residual current relay, toroid, shunt-trip and MCCB/MCB available in ABB. Compliance with protection standard IEC/EN 60947-2 Annex M allows to offer a cumulative operational time (residual current relay, shunt-trip, circuit breaker) guaranteed by the manufacturer. The new ABB ELR front panel residual current relays are tested for this purpose.

Brochure: 2CSC444050B0201



Benefits

- Compliance to IEC/ EN 60947-2 Annex M
- Frequency filter
- Two output contacts
- Prealarm function
- Autoreset function



Always available for your sub-metering needs?

Definitely.



ABB's EQ meters can serve as the 'building blocks' of a sub-metering system, incorporating functionalities that will allow seamless integration in real-time automation and information systems. The C11 meter is an affordable, high-quality, simple-to-install, easy-to-use and truly compact sub-meter for single phase metering. It is mounted on a DIN rail and is suitable for installation in distribution boards and small consumer units, but can also be used in many other applications. Visit our web site to find out more: www.abb.com

Power and productivity
for a better world™



In the news

Distribution and measurement, disconnection and protection: lots of new documents by ABB for those operating in the electrical business, helping them in their work.

The documents and the software can be downloaded from <http://www.abb.com/abblibrary/DownloadCenter/>

Protection

Easy, quick and safe!

Screwless MCB S 200 S

Reach your target faster with the screwless S 200 S

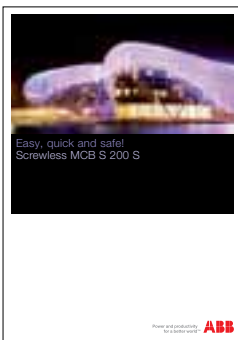

Thanks to the tool-free Easy-Connect Technology, our screwless S 200 S miniature circuit breaker can be wired up far more quickly and easily. Plug in rigid and flexible cables with end sleeves simply and they will fit firmly and securely. Should the wiring be disconnected, pressure need only be applied to the specially developed release lever. So it's just as safe but much faster and no tools are needed!

Flyer: 2CDC002106L0201

With a short video the working principle is shown in a clear and easy way. Take your time, enjoy and let us show you the principle of the new and innovative screwless terminal connection for miniature circuit breakers.

Video



Protection

S800-SCL-SR

The ideal solution for group protection

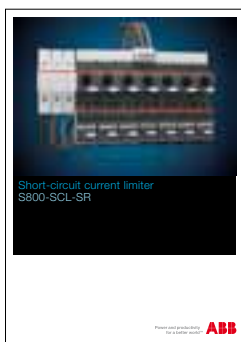

The 16 page brochure fully describes S800-SCL-SR limiter, the self resetting current limiting module, based on the S800 technology. This booklet deals with applications, customer benefits, technical and order data, approved combinations with MCB S800.

The S800-SCL-SR limits the short-circuit current, until the downstream means of protection trips. Its current continuity makes it ideal for group protection: all parallel branches remain operative. This leads to an expanded application range of the low voltage switchgear, whose short-circuit capabilities are usually limited. A typical application is the airflow alignment in wind energy plants. If a failure does not isolate all motor protection devices, the system could possibly be harmed.

S800-SCL-SR can be combined with S800S high performance MCB or, with manual motor starters S800-SCL-SR, can also back up a single circuit breaker or a group of circuit breakers or motor starters (group protection).

ABB already offers the 3-pole short-circuit limiter S803S-SCL, which, differently from the new S800S-SCL-SR, can trip, thanks to a toggle.

Brochure: 2CCC413009B0201



Metering

Choose the right electricity meter

EQ meters are just right for sub-metering



EQ meters can serve as the 'building blocks' of a sub-metering system, incorporating functionalities that allow seamless integration in real-time automation and information systems. EQ meters could be used for sub-metering systems in industries, commercial buildings, residential buildings as well as object metering for cost distribution, improved energy efficiency or optimizing electricity infrastructure. No matter what your need for sub-metering is, EQ meters are just the right choice.

Brochure: 2CMC481002B0201



Catalogue: 2CMC4800001C0201



EQ meters are high-performance, modular DIN rail-mounted electricity meters that are safe, easy to install and can be integrated with existing or future electrical installations. EQ meters are designed to fulfill any type of sub-metering requirement.

Video



Protection

Switching off instead of blowing

Make profits with miniature circuit breakers

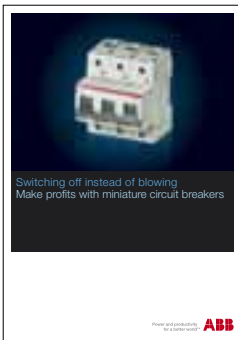

Power Distribution System without fuses? Good reasons to switch now. For many years the fuse was the best choice to protect man and machine from overcurrent. However, what moved into the switch cabinets of private households, over three decades ago, is now also starting to increasingly establish itself – in a more developed form - in industry, business and transport: the miniature circuit breaker.

Brochure: 2CCC413007C0201



Protection

ELR: ABB range of front panel residual current relays

Protection device according to IEC/EN 60947-2 Annex M



The electronic residual current relays allow monitoring and protection of the low voltage distribution network through the use of a toroidal transformer. Protection is achieved in combination with the MCBs and MCCBs. Compliance with protection standard IEC/EN 60947-2 Annex M allows to offer a cumulative operational time (residual current relay, shunt-trip, circuit breaker) guaranteed by the manufacturer. The new ABB ELR front panel residual current relays are tested for this purpose.

Brochure: 2CSC444050B0201



Distribution

IEC 61439

The new standard for low-voltage switchgear and controlgear ASSEMBLIES”

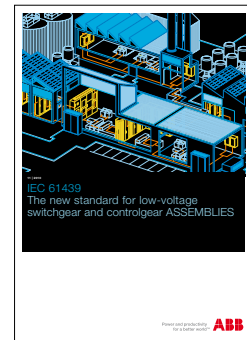

The aim of this guide is to allow panel builders, electrical installers, planners or purchasers to familiarise themselves with the new standards and to point out the main changes that have been introduced as well as elements that remain unchanged.

Brochure: 2CPC000119L0201



Protection

Operational continuity

The safety and reliability of ABB H+Line, switchboards and devices for medical locations

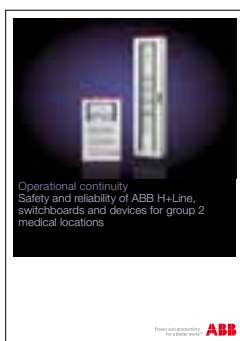

This brand new brochure presents in detail the new QSO range of switchboards, now available in S, M, L, XL, the new QIT series, specifically for the supply and protection of data centres, and the new ISOLTESTER MRM BOX, for management of a group of operating rooms (from 2 to 99) from remot through touch screens. ABB H+Line: ABB technology and safety for hospital locations.

Brochure: 2CSC004033B0201



Command

E 219 multiple indicator lights

The new System pro M compact space saving range of LED lights



Indicator lights are used in electrical equipment and for signalling switching states or indicating faults. The ABB range consists of single, double and triple indicator lights in the smallest size (9 mm width). This new catalogue highlights the benefits of these ABB new devices and describes with schemes and wiring diagrams the many different applications of single and multiple LED indicator lights in electric systems in residential and industrial environment.

Brochure: 2CCC441002C0201



Control

Time, light, comfort

Solutions for comfort, energy saving and simple automation

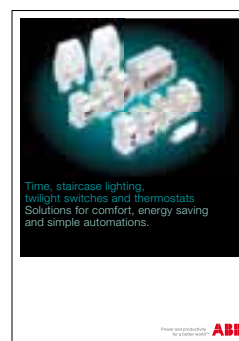

The whole range of ABB command and control devices at a glance, with all technical details and plenty of application notes. Time switches, twilight switches, staircase light switches and thermostats ensure an efficient use of energy in residential, commercial and industrial environment.

Brochure: 2CSC440020B0201



Measurement

Made to measure

Practical guide to the electrical measurements in low voltage switchboards

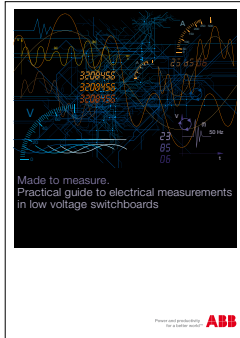

The measurement and monitoring of electrical parameters allow to improve the energy efficiency, the prevention of failure and the programming of maintenance operations, thanks to an advanced identification of problems that, actually, translates into a higher level of protection not just of the plants but of the facilities connected to them.

Brochure: 2CSC445012D0201



Measurement

Complete monitoring of the system

DMTME multimeters and ANR network analysers

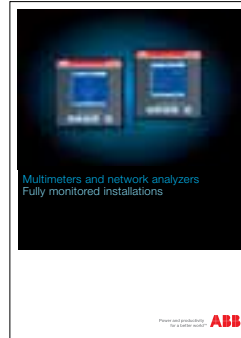

An in-depth knowledge of the operating parameters of the electrical system is useful to optimise the efficiency of the connected appliances, reduce the costs and ensure operational continuity. DMTME multimeters are the ideal measuring instrument to keep equipments and network under control. With ANR network analysers the monitoring of the system's energy consumption and the quality of the network is accurate and complete.

Brochure: 2CSC445050B0201



Software

DMTME Demo

DMTME digital multimeter simulator



Thanks to this simulator, DMTME digital multimeter functions can be discovered interactively. DMTME are simple but rich in functionalities, suitable for commercial and industrial applications. Try them live, with few mouse clicks!

Software: 2CSC445020E5101



Software

E90 Wizard

The right choice always in your hand



With E 90 Wizard, smartphone becomes the new professional tool in the pocket of every ABB installer.

It's called E 90 Wizard; in three clicks this pretty new app for smartphones guides installers in choosing the correct fuse switch disconnecting or fuseholder for each specific application, amongst System pro M compact® offer.

E 90 Wizard app is available for download on App StoreSM at <http://itunes.apple.com/it/app/e90-wizard/id482605787>;



in Android Market you can download at <https://market.android.com/details?id=com.abb.e90facile>
Stay tuned for more news on ABB Wizard Apps!



Software

S200 Wizard

The right choice always in your hand



With S200 Wizard, smartphone becomes the new professional tool in the pocket of every ABB installer.

It's called S200 Wizard; only 5 easy questions results in one single solution. After answering those 5 questions, a short overview shows all mandatory information for choosing the right product. If necessary, a link is routing you to the ABB products detail page for all technical details, certificates, brochures and other documentation.

S200 Wizard app is available for download on App StoreSM at <http://itunes.apple.com/us/app/s-200-wizard/id514542325?mt=8>



and on Android Market. Stay tuned for more news on ABB Wizard Apps!



Top five

Top five most interesting products in their category at a glance, and current ABB suggestions to installers.

In this first issue of Day by DIN, we start with some tips to improve energy efficiency, one of the most talked about subjects at this moment.

ODINsingle

Energy meters



Energy costs are rising. It is, therefore, in the interest of both private and commercial customers to measure energy. If you know how much you consume, you are in a position to be energy efficient, save money and make a positive impact on the environment. With full control over your consumption, you will also be able to cut on your CO2 emissions.

E 210 Series E 250

On-off switches, pushbuttons and indicator lights



Compact modular devices require less space for installation, with a consequent reduction in the size of the switchboard. Easy to assemble, they ensure a reduction in labour time and cable length. The use of low consumption LEDs in the signalling lights of the whole series minimizes consumption.

Latching relays



Used to control lamps from more than one input, latching relays require power only for the brief period of a pulse, without any consumption to hold contact.

Events

ABB at the Light+Building 2012

Light+Building is the world's biggest trade fair for lighting and building-services technology and presents solutions that cut the energy consumption of a building at the same time as increasing the level of comfort. Around 2,100 exhibitors take part in Light+Building at Frankfurt Fair and Exhibition Centre and almost one in two of the over 183,000 visitors comes from outside Germany. Every two years, the industry presents its latest innovations for the fields of lighting, electrical engineering and house and building automation at the fair.

The main theme at Light+Building 2012 will be energy efficiency. Dwindling resources and rising energy prices are big challenges of our times. Efficient and sustainable energy use is therefore urgently needed – true to the European Commission's slogan "less is more". With a 40% share of overall primary energy consumption, buildings are the biggest consumers of energy, ahead of even transport and industry. This is a figure that leaves plenty of room for improvements in efficiency.

ABB will be answering pressing questions regarding the energy future of buildings at the ABB shared stand in Hall 8 F60/G60 in Frankfurt am Main from April 15 to 20, 2012. Energy efficiency in buildings and the topics of smart metering, smart home and electromobility will be our focus at the stand. We will show you the wide ABB product portfolio from energy supply and safe electrical installations, through to door intercom systems and solar inverters.

Video



E 232

Staircase lighting relay



The installation of staircase lighting relay allows the activation of lighting only for the necessary transit time of people in public and private places, avoiding unwanted consumption and saving a lot of energy.

TW

Twilight switches



The possibility to control the lights based on the level of external brightness and a specific time programming allow a more efficient energy consumption, activating lighting only when necessary.

Good morning DIN rail

ABB answers to one of the many questions posted to our experts through email. Send your technical questions to mail.daybydin@abb.com, the most interesting ones will be published and answered on next issues of Day by DIN.

ABB proposes “Class 1”, “Class 2”, and “Class 1 and Class 2” surge protective devices (SPDs). The last product type would seem to include the first two, but is it actually so?

ABB proposes three types of surge protective devices which offer global protection for low-voltage electrical networks:

- “Class 1” (or Type 1) SPDs protect against direct lightning strikes, in other words lightning striking the external lightning protection system (LPS) or the overhead supply line of a building. The current generated by the lightning strike penetrates the electrical system. The phenomenon is unusual but high in power. In this case, ABB recommends the use of OVR T1 “Class 1” SPDs, which are installed at the source of the electrical system.
- “Class 2” (or Type 2) SPDs protect against indirect lightning strikes, when lightning striking near a building induces a surge in its electrical system. The power is lower in this case, but it is a much

more frequent phenomenon. To protect systems against this phenomenon, ABB recommends the use of OVR T2 “Class 2” SPDs, to be installed on the equipment requiring protection;

- “Class 1 and Class 2” SPDs, known as OVR T1+2, protect against both direct and indirect lightning strikes. They are used when there is minimal distance between the MDB and the terminal device and it is necessary to protect them from both types of lightning strikes. They are used, for example, in shelters, telecommunications panels and power centres with monitoring. ABB recommends OVR T1+2 “Class 1 and Class 2” SPDs, to be installed at the source of the electrical system near sensitive devices.

OVR T1+2 “Class 1 and Class 2” SPDs are the best solution for direct and indirect lightning strikes in terms of performance and compact sizes.



Christophe Rios
Product Marketing Manager
DIN Rail Products
ABB



How to choose protection when there is a risk of direct lightning strikes?

Some simple rules for a quick choice:

- If there is no sensitive equipment in the system, install an OVR T1 “Class 1” SPD at the source of the system;
- When there is sensitive equipment located at more than 10 metres from the MDB, install OVR T2 “Class 2” SPDs on it too;
- If the sensitive equipment is inside or near the MDB (<10 m), install an OVR T1+2 “Class 1 and Class 2” SPD.

If the system is at risk of indirect but not direct lightning strikes, the correct choice is OVR T2 “Class 2” SPDs. In this case, using lightning current protection (OVR T1 and OVR T1+2) would not provide any benefit and would increase the overall cost of the system.

The right protection saves space, time and money, while ensuring maximum safety!



E 90 range. Designed by ABB for the most demanding customers



Suitability for disconnection and switching, effective heat dissipation and certified compliance with several international standards are mandatory requirements to meet the needs of the most demanding customers. ABB has dedicated its designers' passion, competence and creativity to the development of E 90 new range of disconnectors and fuseholders. The result is the first AC-22B fuse-switch disconnector, IMQ and UR certified up to 32 A and 690 V. www.abb.com

Precision of energy metering

The conformity to the MID Directive ensures the reliability of energy meters

Aron Svedin: Product Marketing Manager Modular DIN Rail Products - ABB

The range of ABB meters conforms to the MID directive, for both single-phase instruments and three-phase ones. The European Union regulation «Measurement Instrument Directive» MID, published on 30th April 2004 in the Official Journal L. 135 as Directive 2004/22/EC, defines the means of certification for an energy meter for fiscal metering purposes.

This directive is applicable to the devices and systems with measurement functions defined in the specific attachments. The requirements of the energy meters are defined in attachment MI-003.

Before this regulation, the calibration of instruments was subject to national laws. This meant that every device that required calibration could be sold commercially only when a sample of it had obtained national approval and every device had been calibrated.

The MID was created as a result of the EU principles that aim to simplify commerce between nations, with the harmonization of demands and the mutual recognition of the declarations of conformity. The MID directive has the intention of regulating the marketing of measuring instruments until the phase when they are actually put into use. The MID regulation includes the following requirements:

- essential requirements for market trading or for putting new devices into use;

- assessment of conformity to the regulations in force;
- procedure for conformity assessment;
- designation criteria of the notification of a body;
- the identification principles of measuring instruments;
- market surveillance.

Nevertheless, the MID does not regulate how the legal check is carried out (calibration service), neither does it regulate the periodic checks of the devices in use, such as, for example: recalibration, lifespan of the calibration or the maximum transaction limits.

Conformity assessment according to the MID directive

There are different modules provided for conformity assessment.

Module B

Type examination: part of the conformity evaluation procedure, for which a notified body examines the technical design of a measuring instrument and ensures and declares that the technical design corresponds to the appropriate MID Directive requirements.



01

01 ODINsingle energy meters for single-phase networks and DELTAplus energy meters for three-phase networks, both MID certified and suitable for fiscal use



Product development	Modules B + F	Modules B + D	Modules H1
Development - Planning - Designing	Type B examination	Type B examination	Inspection of planning
Series production		Quality certification system D	Complete quality system
Finished product	First calibration F		

02

02 Correspondence between the different phases of development of a product and the assessment modules

Module D

Declaration of type conformity based on the quality assurance of the manufacturing process: part of the conformity evaluation procedure, for which the manufacturer fulfils the obligations defined by the Directive and ensures and declares that the concerned measuring instruments conform to the type described in the EC examination certificate and correspond to the appropriate MID Directive requirements.

Module F

Declaration of type conformity based on the verification of the product: part of the conformity evaluation procedure, for which the manufacturer fulfils the obligations defined by the Directive and ensures and declares that the concerned measuring instruments, that have undergone tests and inspections, conform to the type described in the EC examination certificate and correspond to the appropriate MID Directive requirements.

Module H1

Declaration of type conformity based on the complete assurance of quality and control of the design: part of the conformity evaluation procedure, for which

N.	Symbol
1	Type code
2	Voltage range
3	Frequency
4	Base current (max. current)
5	Accuracy class
6	Frequency of impulse signal
7	Frequency LED
8	Series number
9	Week of production
10	Year of production
11	Range of exercise temperature
12	Clock back-up time
13	Protection class
14	MID mark - Safety declaration - Year of verification - Notified body
15	Bar code
16	
17	Network type

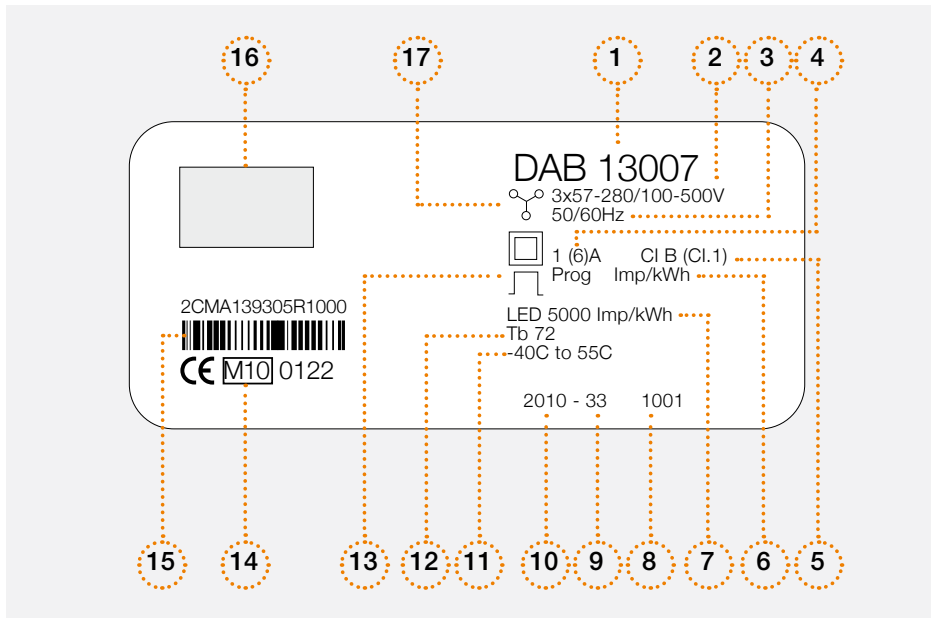

03

03 Example of type of product label, on which all the information regarding the MID mark, the conditions of use, and the technical characteristics appear



Aron Svedin
Product Marketing Manager
DIN Rail Products
ABB

the manufacturer fulfils the obligations defined by the Directive and ensures and declares the worldwide conformity of the concerned instruments to the appropriate requirements of the EU Directive.

Procedure for MID conformity assessment

The conformity evaluation of the measuring instruments occurs according to the procedure chosen by the manufacturer. The evaluation criteria regard the three phases for making a product conform, the type of assessment and the notified body.

For active electrical energy meters, the manufacturers can choose the assessment modules:

- B + F, applicable to single production batches;
- B + D, applicable to production with the certified quality system ISO 9001.
- H1, applicable to products with their own testing laboratory and certified quality system ISO 9001.

ABB has chosen modules B and D as procedures for the assessment of conformity of their energy meters. The notified body appointed to carry out the conformity test is NMI, a Dutch corporation. The MID covers the bringing of the devices into conformity in terms of development, series production and the finished product; the 02 label establishes the correspondence between the different phases and the assessment modules.

Regulations applicable to electrical energy meters

The MID has also redefined the Standards for electrical energy meters in asso-

ciation with the manufacturers' organisations CITEF and CENELEC (the European Committee for Standardization). The objective was to get the European regulation EN as close as possible to the existing international regulation IEC. Nevertheless, it has been impossible to prevent the arisal of important differences between the EN and IEC regulations.

- designation of class according to EN 50470 with class A, class B, class C;
- designation of class according to IEC 62053 with class 2, class 1, class 0.5.

Marks required for active electrical energy meters

In addition to the name of the manufacturer and the name of the product, on active electrical energy meters there must also be an affixed metrology mark to satisfy the MID Directive. The devices must carry the CE mark. Furthermore, a rectangular mark must be applied with a frame containing the letter M, the last two digits of the year of manufacture and, lastly, the identification number of the notified body. The precision class, the unit of measurement and the series number must also be clearly visible (Figure 03).

Additional information must also appear including the technical characteristics, device outline, number of certification tests and, in the case of electrical meters, the software version. Furthermore, every dispatch of energy meters must be accompanied by the relative declaration of conformity for the EU country concerned.

ABB has integrated a declaration of conformity in its instruction and assembly manual.

Glossary

Active energy

Quote of available energy to carry out a job.

Accuracy class

For a measuring device it is an index of its accuracy.



SMISLINE TP. Touch proof system Power and Safety



Absolutely safe without protective equipment: SMISLINE TP ensures that load-free devices and components can be snapped on and off under voltage without the need for additional personal protective equipment to guard against electrical hazards. That opens up completely new prospects for you when it comes to installation, operation and flexibility. www.abb.com

IEC 61439

The new standard for low-voltage switchgear and controlgear ASSEMBLIES

A low-voltage switchgear and controlgear assembly (ASSEMBLY) is a combination of low-voltage switching devices together with associated equipment (for controlling, measuring, signalling, etc.) complete with all the internal mechanical and electrical interconnections and structural parts. As with every component of an electrical installation, the ASSEMBLY also has to comply with its appropriate standard.

Cristian Dell'Anna: Product Marketing Manager Enclosures - ABB

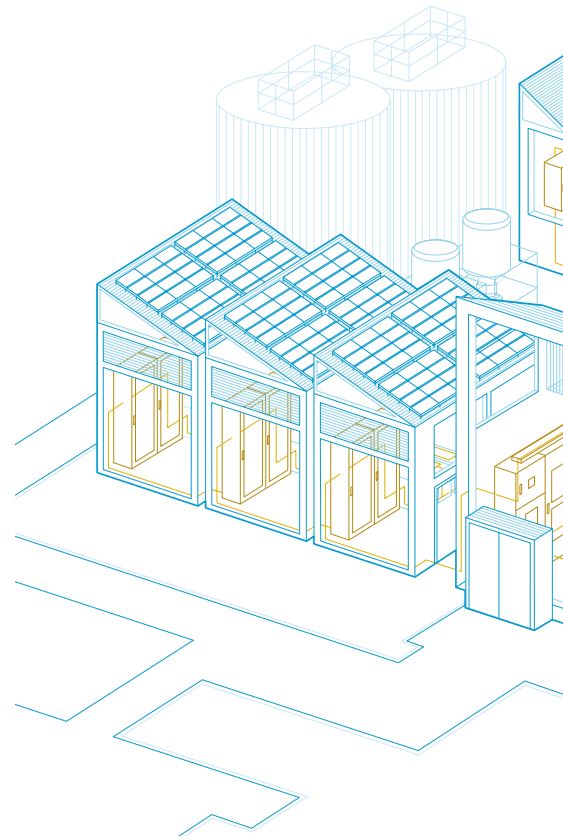

In January 2009 the IEC 61439, the new standard for low-voltage switchgear and controlgear ASSEMBLIES, was published. This was the aim of an international project group which had been working on a task named "radical restructuring and revision of IEC 60439 series" since 1998. This initiative was introduced by several countries following dissatisfaction with the IEC 60439 series. The purpose was to harmonise and define all general requirements for low-voltage electrical ASSEMBLIES.

Reaching an agreement has proven extremely challenging, but the first parts of the new standards have been published. For each type of electrical ASSEMBLY only two parts of the standard are necessary to determine all requirements:

- the basic standard IEC 61439-1 "General rules"
- the specific ASSEMBLY standard

The current IEC 60439

The current IEC 60439 standard applies to enclosures for which the rated voltage is under or equal to 1000 V AC (at frequencies not exceeding 1000 Hz) or 1500 V DC. The standard makes a distinction between type-tested assemblies (TTA) and partially type-tested assemblies (PTTA). The following parts are mentioned and have equal weighting. There is not a formal hierarchy. Each part is a complete entity and can be used on an individual basis:

IEC 60439-1

type-tested and partially type-tested assemblies

IEC 60439-2

particular requirements for busbar trunking systems (busways)

IEC 60439-3

particular requirements for low-voltage switchgear and controlgear assemblies which are to be installed in locations where unskilled persons have access for their use.

IEC 60439-4

particular requirements for assemblies for construction sites (ACs)

IEC 60439-5

particular requirements for assemblies intended to be installed outdoors in public places – Cable distribution cabinets (CDCs) for power distribution in networks

The standard remains valid until 2014

The new IEC 61439

The new IEC 61439 standard applies to enclosures for which the rated voltage is under 1000 V AC (at frequencies not exceeding 1000 Hz) or 1500 V DC. The standard defines the design verified ASSEMBLIES and eliminates completely the categories TTA and PTTA.

In order to conform to the standard, type tests have been replaced by a design verification which can be carried out by the three following equivalent and alternative methods: testing, calculation/measurement or application of design rules.

The following parts are mentioned and do not have equal weighting. There is a formal hierarchy. Each part can not be used individually:

- **IEC 61439-1** "General rules"
- **IEC 61439-2** "Power switchgear and controlgear ASSEMBLIES"
- **IEC 61439-3** "Distribution boards"
- **IEC 61439-4** "ASSEMBLIES for construction sites"
- **IEC 61439-5** "ASSEMBLIES for power distribution"
- **IEC 61439-6** "Busbar trunking systems"

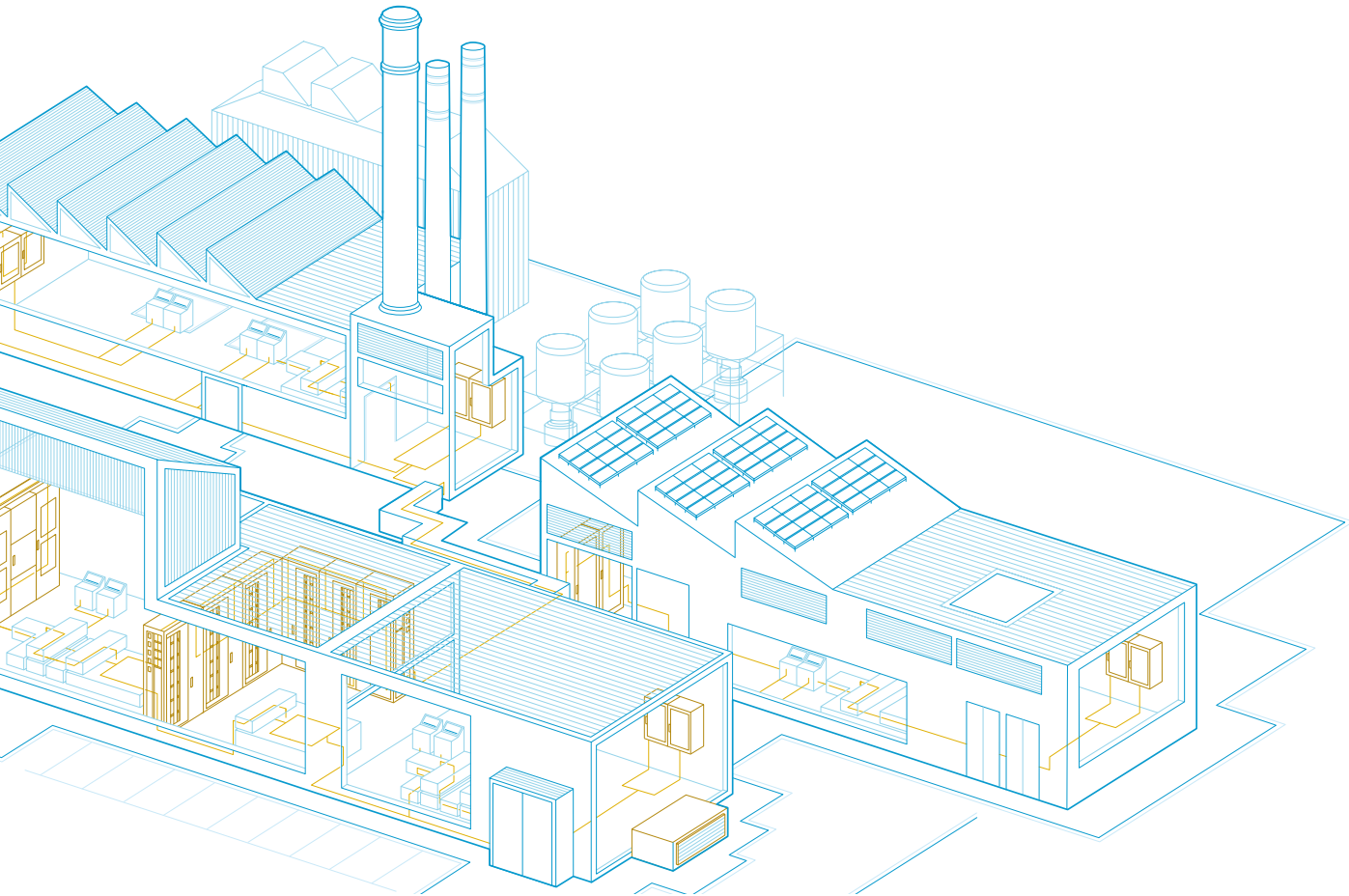

Part 1 is the general rules part and cannot be used alone to specify an ASSEMBLY.

Part 2 defines the specific requirements of power switchgear and controlgear ASSEMBLIES (PSC ASSEMBLIES) and must be used with Part 1. This is the only part that has a double role, it covers PSC ASSEMBLIES and any ASSEMBLY which is not covered by any other specific parts.

Parts 3-X are still under preparation but are already mentioned in Part 1. These could be more than four, as additional parts may be developed as the need arises.

Summarising: With the currently used IEC 60439, the rule is “one part for each type of

ASSEMBLY”. With the new IEC 61439 the rule is “two parts for each type of ASSEMBLY”. The compliance of an ASSEMBLY is declared referring to the specific ASSEMBLY standard (e.g. IEC 61439-2), and the compliance with the general rules (IEC 61439-1) is always implicit. The sentence “TTA switchgear according to IEC 60439-1” is now replaced by “Power switchgear and controlgear ASSEMBLIES according to IEC 61439-2, design verified ASSEMBLY”. The validity of the two standards will overlap until 2014 and prior to this date, ASSEMBLIES can be manufactured according to IEC 61439 or IEC 60439.

Relationship between the two standards is as shown in the table below:

IEC 61439-1 +	IEC 61439-2	replaces	IEC 60439-1 (still valid until 2014)
	IEC 61439-6	will replace	IEC 60439-2 (still valid)
	IEC 61439-3	will replace	IEC 60439-3 (still valid)
	IEC 61439-4	will replace	IEC 60439-4 (still valid)
	IEC 61439-5	will replace	IEC 60439-5 (still valid)

Main changes – More than a single digit change...

The new IEC 61439 includes the following significant technical changes with respect to the last edition of IEC 60439.

Responsibility split:

New terms have been introduced and there is a split in product responsibility between the “Original manufacturer” (e.g. ABB, responsible for carrying out the original design and the associated verification of an ASSEMBLY) and the “ASSEMBLY manufacturer” (e.g panel builder using an ASSEMBLY system from an Original Manufacturer) assuming responsibility for the completed ASSEMBLY.

The Assembly Manufacturer may be a different organisation to the Original Manufacturer. Where the ASSEMBLY Manufacturer introduces changes to the ASSEMBLY configuration tested by the Original Manufacturer, he is deemed to be the Original Manufacturer in respect of these changes and has to carry out the design verification.

Design verification replaces TTA and PTTA categories:

Design verification replaces type tests so the discrimination between type-tested assemblies (TTA) and partially type-tested assemblies (PTTA) is eliminated.

Three different but equivalent types of verification of requirements are introduced:

Verification by testing (test made on a sample of an ASSEMBLY or on parts of ASSEMBLIES to verify that the design meets the appropriate requirements. This method is equivalent to the currently implemented type tests). Verification by calculation/measurement (calculations applied to a sample of an ASSEMBLY or to parts of ASSEMBLIES to show that the design meets the appropriate requirements). Verification by application of design rules (specified rule to verify the design of an ASSEMBLY).

The selection of the appropriate verification method has to be made according to annex D, which explains the available verification options for each characteristic which is to be verified, as shown in the table below:

Characteristic to be verified		Verification options available		
		Verification by testing	Verification by calculation	Verification by design rules
10.2	Strength of material and parts	Yes	No	No
10.3	Degree of protection of enclosures	Yes	No	Yes
10.4	Clearances and creepage distances	Yes	Yes	Yes
10.5.2	Effective continuity between parts and PE	Yes	No	No
10.5.3	Effectiveness of the ASSEMBLY for external faults	Yes	Yes	Yes
10.6	Incorporating of apparatus	No	No	Yes
10.7	Internal electrical circuits and connections	No	No	Yes
10.8	Terminals for external conductors	No	No	Yes
10.9.2	Power frequency withstand voltage	Yes	No	No
10.9.3	Impulse withstand voltage	Yes	No	Yes
10.10	Temperature rise limits	Yes	Yes	Yes
10.11	Short-circuit withstand strength	Yes	Yes	Yes
10.12	EMC	Yes	No	Yes
10.13	Mechanical operation	Yes	No	No

Tests that have been made in accordance with IEC 60439 and that fulfil the requirements of the new IEC 61439 need NOT be repeated.

The second stage verification is the routine verification. This is performed to verify that the materials and workmanship are in accordance with the requirements of the standard. Routine verification replaces the current "routine test". It is more detailed but essentially the new requirements are the same as in the IEC 60439. This verification has to be carried out for each completed ASSEMBLY and it is the responsibility of the ASSEMBLY Manufacturer.

Comparison between the current and the new verification "flow":

Additional verification:

New requirements from the standard IEC 62208 (Empty enclosures for ASSEMBLIES) have been added:

- verification of resistance to UV radiation for outdoor plastic enclosures
- verification of corrosion resistance
- mandatory declaration and confirmation of an impulse rating
- lifting, mechanical impact and marking

Other changes:

Temperature rise:

Temperature rise requirements have been explained more clearly and have been adapted to the state of the art.

One of the following methods is allowed for verification:

- testing with current
- derivation (from a tested design) of ratings for similar variants
- calculation

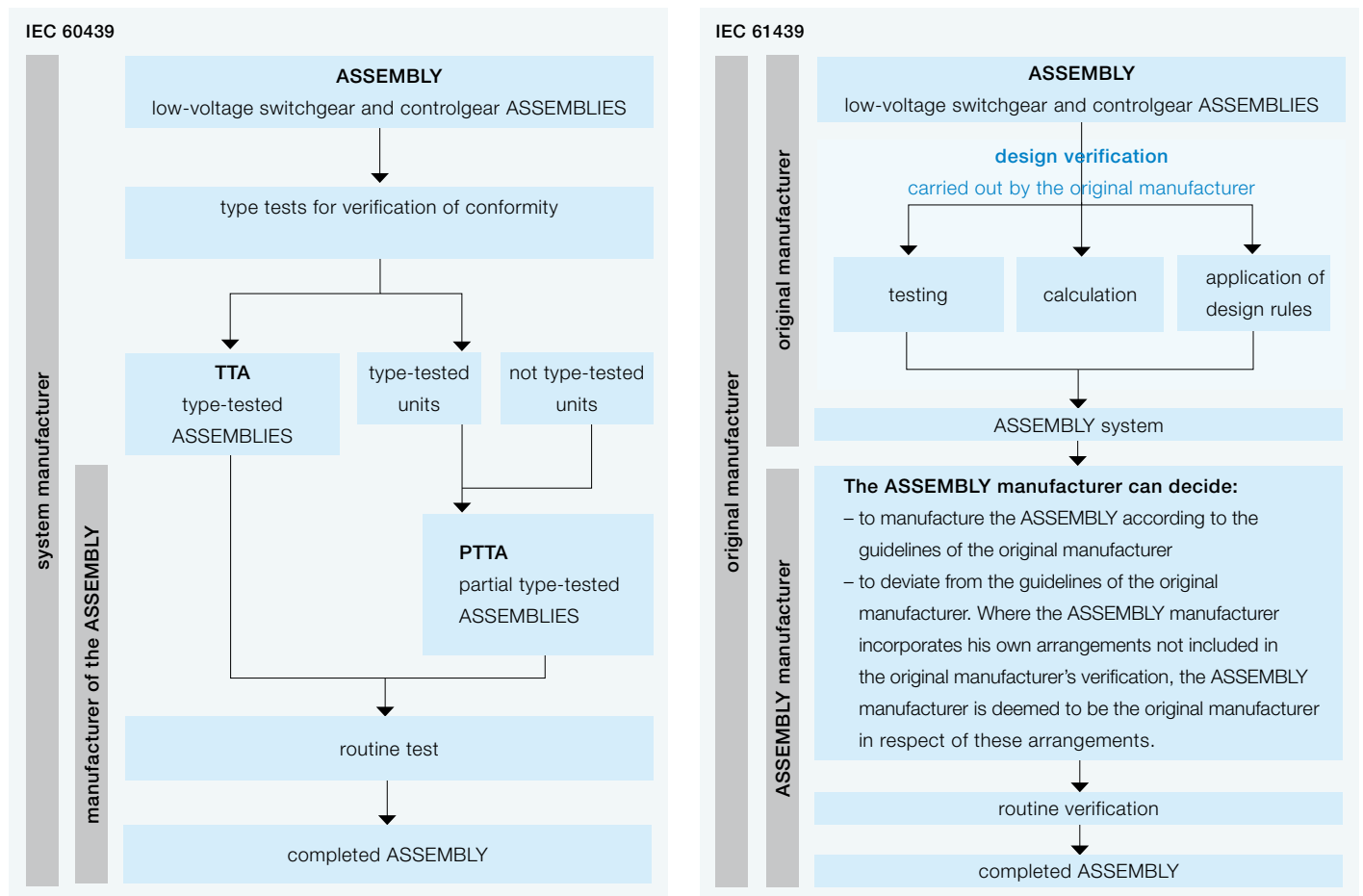

RDF

The rated diversity factor is covered in more detail. In practice it is assumed that multiple functional units are not fully loaded simultaneously.

Labels

Labels have to be subjected to testing to verify their legibility. The following information is required on the label:

- ASSEMBLY Manufacturer's name
- Identification number
- Date of manufacture (NEW!)
- IEC 61439-X (the specific part "X" has to be specified) (NEW!)

"Grey" areas

A number of "grey" areas have been clarified:

- neutral conductors will have a current rating equal to 50% of the corresponding phases if not otherwise specified
- agreements between Customer and Manufacturer have been more detailed, extended and listed in annex C
- it is mandatory to specify the rated current of the ASSEMBLY
- a technical report IEC 61439-0 "Guide for specifying ASSEMBLIES" is under development for a better understanding of the new standard
- questions regarding the internal form of separation have been clarified (e.g. a moulded case circuit breaker's casing provides separation from other functional units)

Summary table with the main changes

IEC 60439	IEC 61439
IEC 60439-1	IEC 61439-2
Type-tested and partially type-tested assemblies	Design verified ASSEMBLIES
Mix of different rules and demands in each part	Clear structure: IEC 61439-1 "General rules" IEC 61439-2 ... -6 "Subsidiary parts" (product standard)
Each part is a complete entity and can be used on an individual basis	Each "subsidiary part" is based on the "general rules" (Part 1) and includes only the specific additional rules for the specific product
Testing each type of ASSEMBLY: Partially type-tested or type-tested	Three alternative methods for verification: Test, calculation/measurement, design rules
Annex E: Agreements between Customer and Manufacturer	Annex C: Agreements between Customer and Manufacturer are more detailed and extended
	Shared responsibility: Original Manufacturer vs. ASSEMBLY Manufacturer
	Technical changes and clarifications: Diversity factor, verification of temperature rise, mechanical characteristics, neutral conductor 50%, additional verification (from IEC 62208)



Cristian Dell'Anna
Product Marketing Manager
Enclosures
ABB

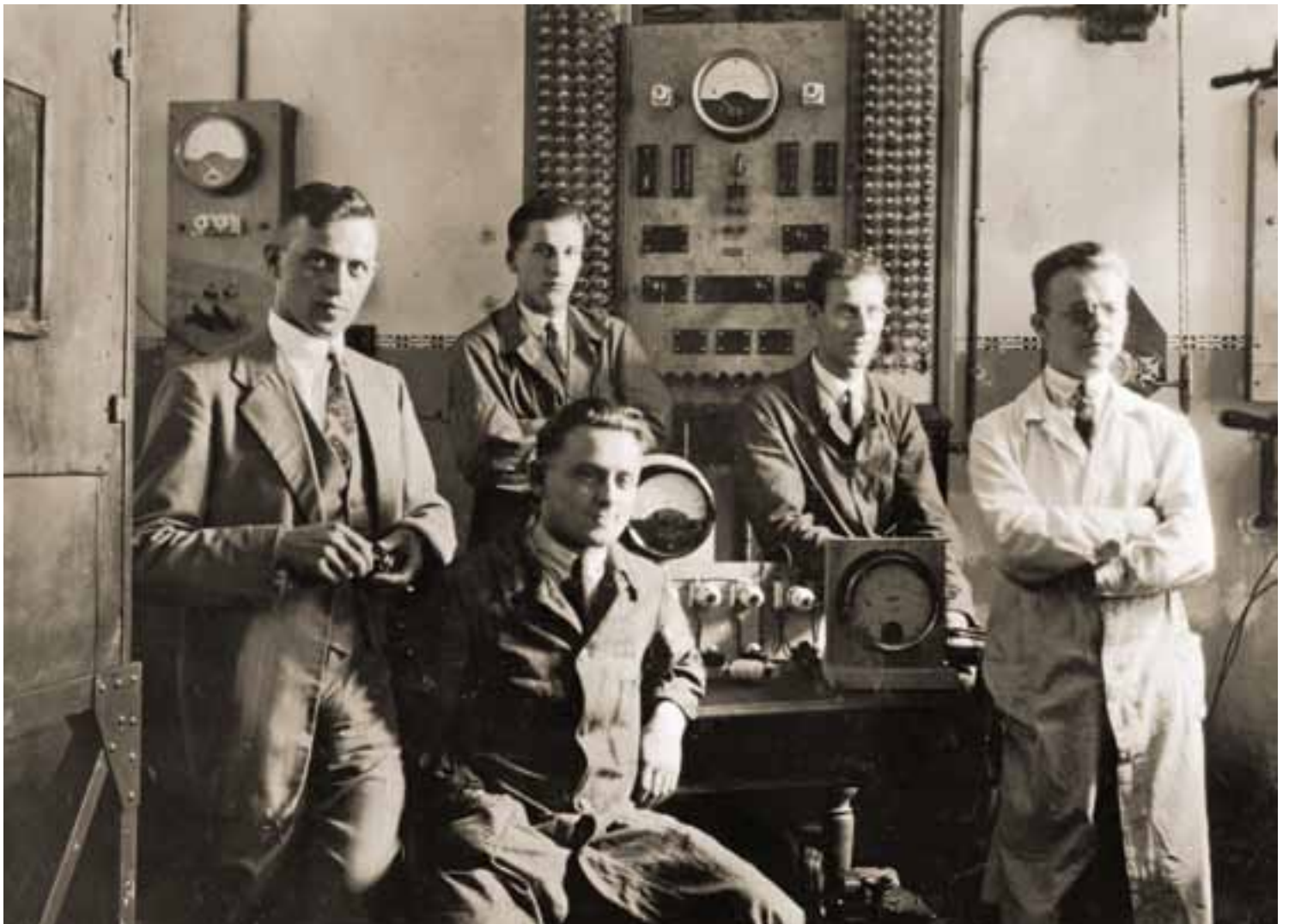

S 200 MCB. In 1923 the first of it's kind – today the best.



Back then and still today we are a trendsetting pioneer and technical leader for easy, safe and reliable use of electricity. Our circuit breakers S 200 and S 200 M are a living proof. So, with the new colored real contact position indication you can see the status within a twinkle of an eye. The optimized plane terminal plates guarantee right connection and can be reached even when the MCB is already installed. These and a lot more benefits make the miniature circuit breakers an effective addition to the successful System pro M compact®. Here you can find a wide range of compatible components for all your installation needs. For more information, see www.abb.com

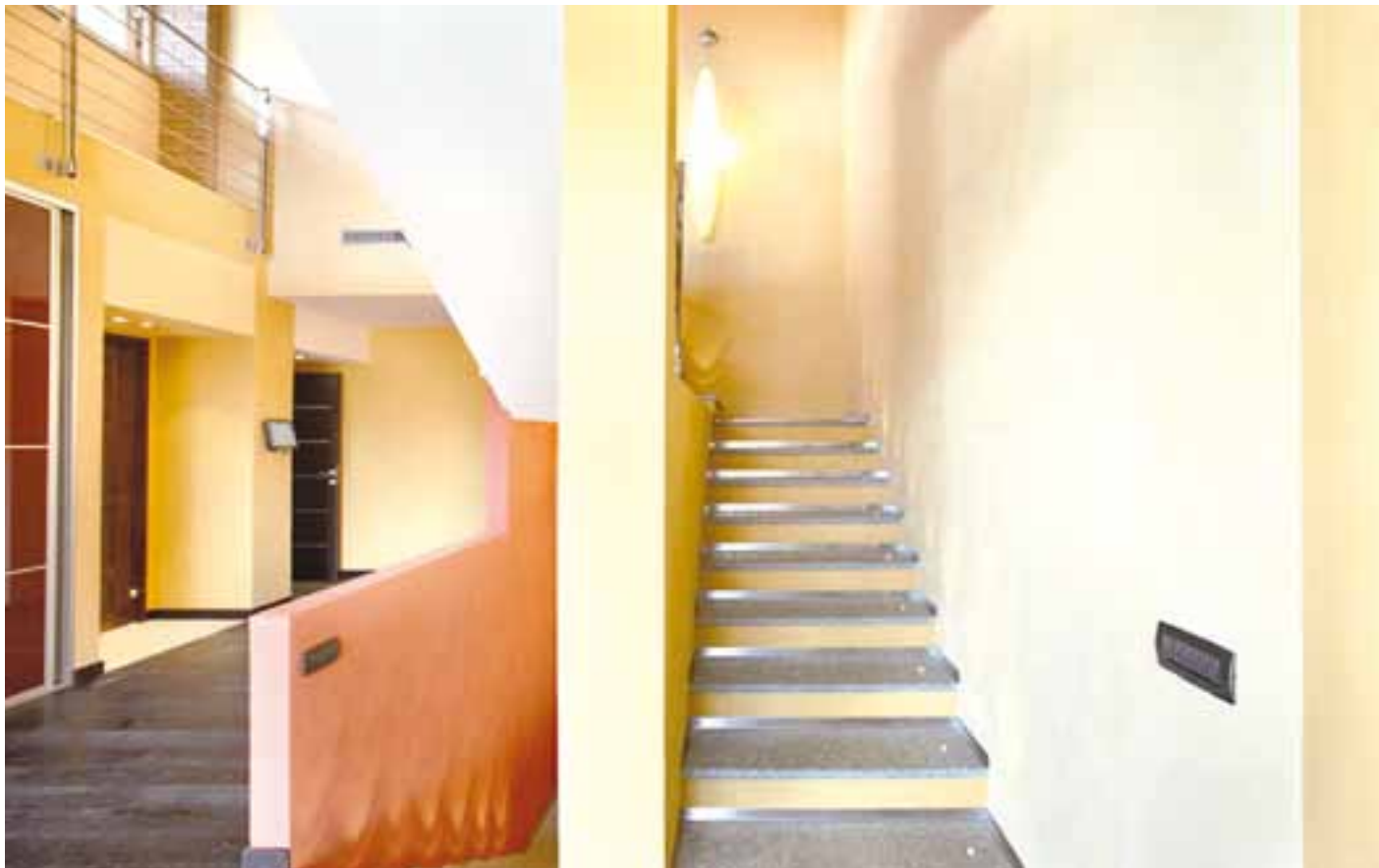

Energy saving ideas E250 latching relays

Francesca Sassi: *Product Marketing Manager DIN Rail Products - ABB*

Do you know that using latching relays instead of contactors in lighting circuits no coil needs to be powered, with a saving of around 2W per relay?

The global energy saving for each relay is greater than 5 kWh a year (for an average use of 8 hours a day). The latching relays permit, moreover, the control of the lighting with an unlimited number of pushbuttons. The realization of the circuit with parallel keys is very simple! This makes it particularly suitable to be used in more complex lighting plants, when, for example, the sequential control of the utilities via a single circuit of pushbuttons is required.

These devices can be used to realize innovative solutions, ensuring the maximum saving of energy, thanks to their design philosophy, which consumes only in the brief period of the duration of the impulse control.

E250 latching relays allow electrical energy saving and the simplification of the lighting circuit wiring: fewer cables, less time needed to connect the devices and lower CO₂ emissions!





Is it possible to switch off AC / DC?

Certainly.



The S200MUC impresses with its performance range and the accordingly large amount of approvals. Its high inbuilt short circuit breaking capacity across the entire model line, its flexible application for both direct and alternating currents and its approval and compliance in accordance with all major international and local standards make it truly unique. The miniature circuit breaker is a valuable addition to the existing System pro M compact® range which allows all known components to be combined effortlessly with the new model line. Whether warehousing and project engineering, planning and installation or maintaining your equipment, the S200MUC is a simple and flexible solution. For more information, see www.abb.com



Urban legends

Exploding the myths and reconsidering convictions

Nowadays we use surge protective devices every day but we still have doubts and curiosities fed by the many urban legends on the subject. Let's have a look at a few and try to better understand.

Christophe Rios: Product Marketing Manager DIN Rail Products - ABB



“The discharge kiloamps of a SPD must be coordinated with the short circuit current of the panel”

This belief is due to a misunderstanding. The short circuit current of a panel and the discharge current of an SPD are both measured in kiloamps. However, a short circuit current normally has a sine-wave shape with a frequency of 50 Hz whilst the discharge current of a SPD has the form of a very brief impulse of just a few microseconds.

Consequently, even the energy content (I^2t) of a short circuit and of a discharge are very different. Once the misunderstanding has been cleared up it is evident that there is no relationship between the I_{sc} of a switchboard and the discharge current of a SPD.

So, how do you choose the discharge current or impulse of a SPD?

It is easier than it seems:

- for Type 1 there is nothing to choose, the value is set by Standard IEC 62305: nearly all SPDs have a value of 25 kA per pole and are equipped, therefore, for the worst case foreseen by the Standards in force;
- for Type 2, the nominal discharge current (I_n) value foreseen by the standard IEC 62305 is 5 kA,; therefore, a Type 2 SPD must have at least 5 kA of I_n .

For practical reasons it is nearly always advisable to choose an SPD with at least 20 kA of I_n to guarantee an adequate length of working life.

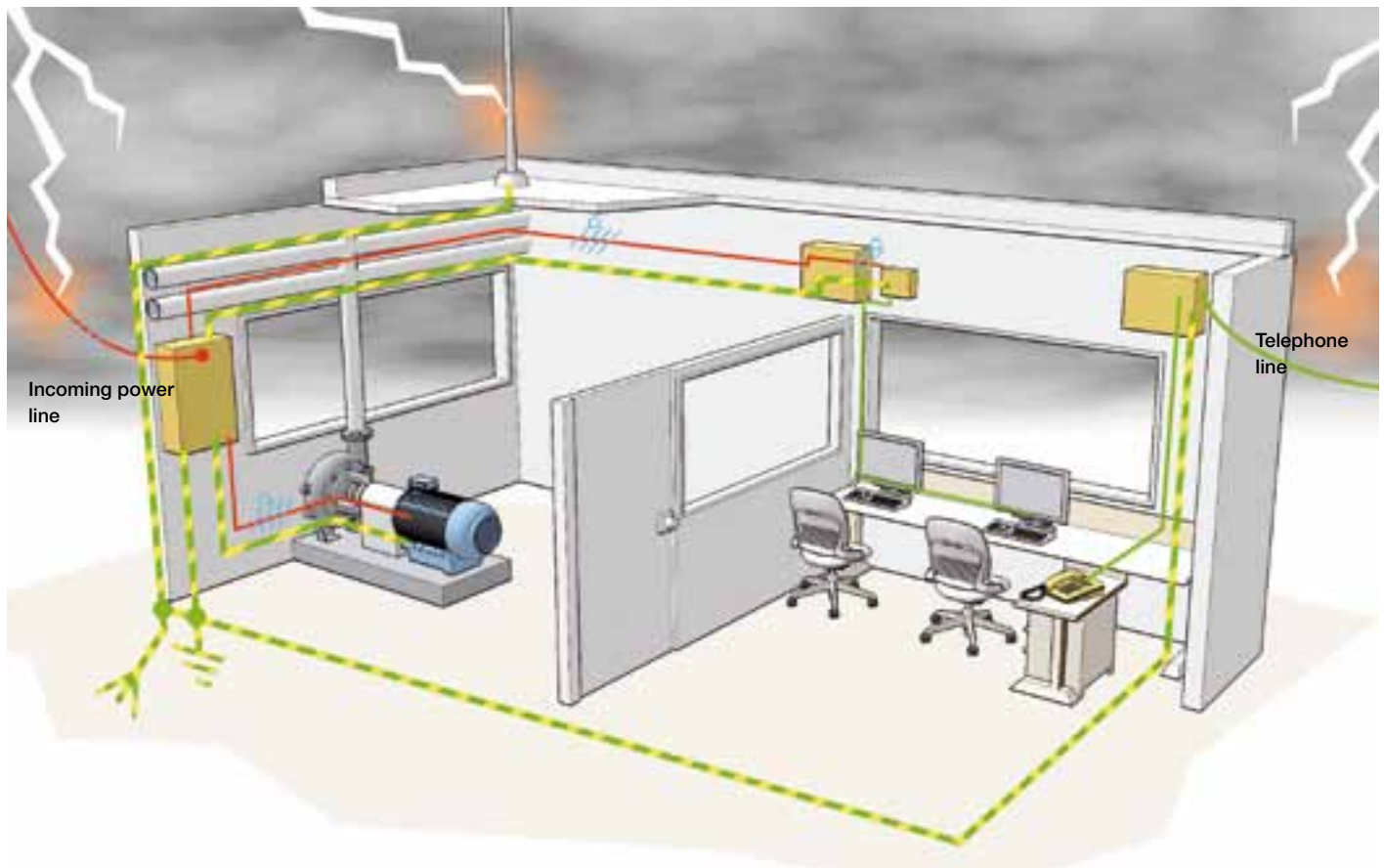

“In a triphase system with 400 V AC voltage a SPD with a rated voltage of 400 V AC must be installed”

Other misunderstandings. Type 1 and Type 2 surge protective devices are designed to be installed between network and ground, not in series. The “rated voltage” of a SPD is, therefore, that measured between the active conductors (phase and neutral) and the earth conductor.

In a 400 V three-phase network, with or without neutral, this voltage will always be equal to 230 V! The only rare case in which it is necessary to use SPDs with U_N 400 V on a 400 V three-phase network is in IT systems: in these, in the case of a first ground fault, an automatic interruption of the power supply is not foreseen. A SPD with 230 V voltage would be subjected to a phase/earth voltage much higher than the nominal voltage and consequently there would be the risk of a failure or fire.

“In a main distribution board it is always best to provide a Type 1 SPD”

It depends! In a very large public building or an industrial unit, the risk analysis according to CEI 81-10 probably foresees the installation of a LPS, acronym for ‘Lightning Protection System’, such as a lightning rod or Faraday cage.

In this case the Type 1 SPD will be necessary to protect against damage due to lightning striking the building.

If no LPS is foreseen, the installation of a Type 1 SPD in the MDB will cause a notable increase in costs without any benefits: put simply, it will never trip...!

“To protect a SPD it is necessary to use fuses, breakers are not suitable”

This is also an “Urban legend”. Some say that the inductance in series to a circuit breaker, run by the discharge current, reduces the efficiency of the SPD. In truth, the product Standard of the SPD, IEC 61643-11, sees to it that it is the manufacturer who provides a suitable and coordinated back up protection to install upstream from the SPD.

The sizing is carried out in the laboratory trying numerous, different, combinations of SPD and protective devices. With most of its products ABB offers the possibility of using either fuses or MCBs.

So what about inductance? As we all know, the inductance of a coil depends on the frequency; a few tests in the laboratory are sufficient to show that the inductance of a MCB on the typical frequencies of atmospheric phenomena (many kHz) becomes neglectable.



Surge protective device OVR T2 3N 40 275s P



Christophe Rios
Product Marketing Manager
DIN Rail Products
ABB

“When lightning strikes and the SPD trips, the SPD must always be replaced”

No, the SPDs are not “disposable”! Also because, if this were so, since there can be numerous atmospheric discharges during a thunderstorm, the SPD would be totally ineffective. In reality, SPDs are designed and tested in order to trip and to return as good as new at least 15 times, if subjected to their rated discharge current.

Given that statistically speaking the discharge current induced by the atmospheric phenomenon is inferior to the rated current, the SPD can trip even hundreds of times before reaching the so-called “end of life”. This is the reason why SPDs are installed every day, but changing a cartridge at the end of its life is a rare occurrence.

“A Type 2 SPD is nothing more than a varistor...”

The varistor is a fundamental component of all Type 2 SPDs, but we must not forget that varistors have two characteristics which a SPD must remedy: they end their operative life in short circuit and they conduct a small permanent current. In order to prevent the short circuit effects on the life of the varistor, a small, essential element is provided inside a SPD: a thermal disconnecter which isolates the varistor from the network in case of overheating, ensuring a safe end of life for the SPD.

Instead, in order to prevent the permanent earth current, which could involve the risk of indirect contacts, in some Type 2 SPDs the N-PE module, which is designed to lead the discharge current towards the earth conductor, is not realized with a varistor, but with a voltage switching type element (for example, a spark gap), able to permanently prevent the current flow towards the PE.

All ABB OVR T2 1N and 3N SPDs are realized with this technology.

“The remote signalling contact tells me the SPD has intervened”

No, the signalling contact switches only when the SPD has reached the end of its operative life. Very useful in the event of unprotected distribution boards, the information can be used, for example, in order to suddenly replace the cartridge in end of life and to restore the protection from the overvoltages.

“A SPD for alternative current can also be used in direct current; it is just a matter of multiplying its rated voltage by the root of two”

This is the principle for which many SPD for alternative current at 400 V have without warning become SPDs for photovoltaic at 600 V DC.

The ABB position has always been very clear on this point: the varistors sooner or later go into short circuit and interrupting a short circuit in direct current is much more difficult than in current. It cannot, therefore, be absolutely guaranteed that the thermal disconnecter integrated in a SPD designed for alternative current is able to guarantee the disconnection when the same SPD is installed in a photovoltaic system. According to UTE C 61 740-51, the manufacturer shall test the products under DC condition and shall declare specific DC characteristics of the SPD.

Doktor Wise

The reliability of ABB's experience in its answers to every need arising from the work of professionals in the sector. In this section an ABB expert answers to the most frequently asked questions regarding the use of DIN rail and front panel products, to resolve problems and propose the most suitable solutions for every application.

Francesca Sassi: Product Marketing Manager DIN Rail Products - ABB

What's the meaning of "measurement in TRMS"?

When electric energy is generated the waveform of the voltage is sine-wave.

The current used by a purely linear, resistive (for example, filament lamps) or inductive (motors and transformers) loads has the same course and, therefore, the same waveform as the voltage which feeds it. Furthermore, in linear loads the current waveform is equal to that of the voltage (both are sinusoidal).

A non-linear load (for example, fluorescent lamps or electronic equipment), instead uses a current that does not have the same waveform as the supply voltage, but is distorted due to the presence of harmonics, sine waves with frequency equal to integer multiples of the fundamental wave (figure 02). The current harmonics interact with the impedance of the distribution system, creating distortions of the voltage and energy losses.

The measurement instruments can be of two types:

- instruments which measure the effective RMS (Root Mean Square) value of the system;
- instruments which measure the effective TRMS (True Root Mean Square) value of the system.

The instruments that measure the effective value of the system (RMS) estimate the average value of the rectified wave, multiplied by the form factor 1.11 (typical of the sinusoidal wave), carrying out an approximate measurement of the effective value of the wave (figure 03).

The instruments that measure the true effective value (TRMS) implement, instead, the following operations:

- sampling of the wave during the entire period;
- square the samples;
- sum the squared values and provide the average;
- calculate the square root (figure 01).

In the presence of distorted waves it is always necessary to measure the true effective value (TRMS) because, in this way, errors due to the harmonics are avoided, which are subtracted from the total wave; moreover, measuring the TRMS of a wave allows to identify the load generating that waveform and the definition of the equivalent of the original waveform in direct current, or in alternating current.

What is the difference between cosφ and Power factor?

The cosφ is the displacement angle between voltage and current in a alternating current electric system. In a purely resistive system, the displacement is null and the cosφ is equal to 1.

The Power Factor is the ratio between the active power and the apparent power. In general, the power factor and cosφ are the same but in the presence of electric lines with harmonic content it is necessary to talk of Power Factor so that the harmonic effect is also considered in the calculation. During non sinusoidal operations in non sine-wave systems talking about cosφ is meaningless, only Power Factor makes sense.

$$Y_{TRMS} = \sqrt{\frac{\sum_{i=1}^n [Y_i]^2}{n}}$$

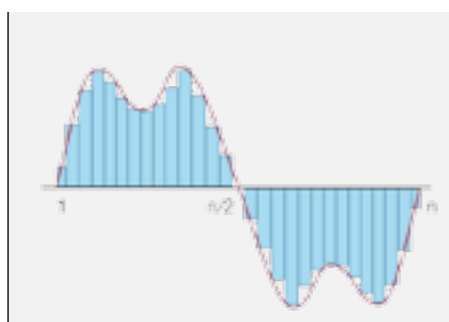

01

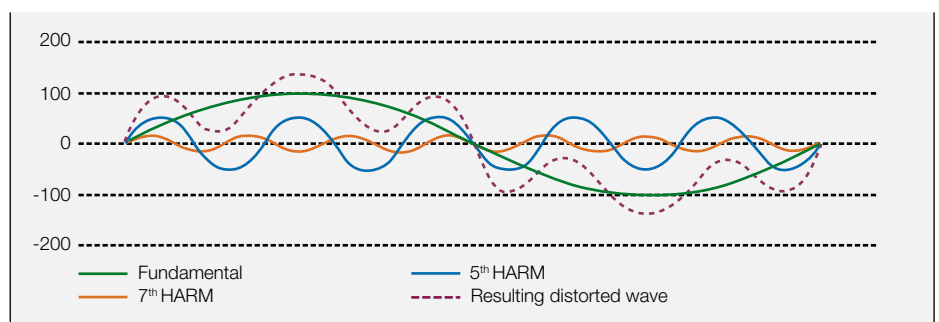

02

How can you ensure the protection of a digital instrument?

In order to ensure the correct protection, it is always recommended to insert MCBs or fuses onto the feeding cables of the digital instruments and at the voltmetric measurement inputs.

What is the earthing of the CT secondaries for?

The earthing of the secondaries of the CT serves to provide a reference towards earth in the case of a transformer failure and does not generally influence the measurement. However, if there is not neglectable voltage between neutral and earth, this could negatively influence the measurement, in the event of instruments with measurement inputs not galvanically isolated.

What does THD mean?

The THD, Total Harmonic Distortion, is the total harmonic distortion of the wave, which considers the contribution of all the harmonic components present. The THD is expressed as a percentage with respect to the fundamental wave and is a useful indicator of the presence of harmonic disturbances in the network.

Direct and indirect measurements: how do you set the correct transformation ratio?

The direct measurement is only possible when the rated quantity to measure has a level within the capacity of the instrument.

When the rated quantity to be measured is larger than the capacity of the measuring instrument, it is necessary to interpose a transformer that reduces the rated quantity and supplies the instrument with values compatible with its capacity. The reading implemented through a measurement transformer is defined as indirect measurement, because it does not occur directly on the line examined.

All the multifunction digital instruments require an indirect insertion through current transformers and, sometimes, with voltage transformers. The main measurement parameters to set up are the transformation ratios of the CT and the VT, defined as a mathematical ratio between nominal value and secondary value; for example, setting the transformation ratio of a CT CT3/100 with secondary at 5 A, means setting $k_{CT} = 100 : 5 = 20$.

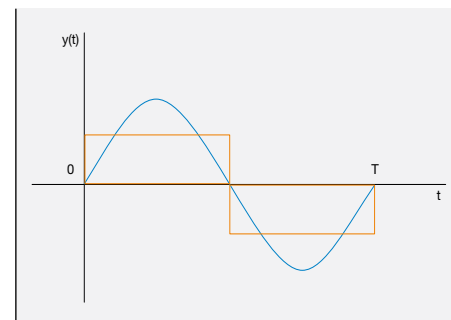

03

- 01 True effective value of a TRMS non-sinusoidal signal
- 02 Waveform with harmonic components
- 03 Effective value of a RMS sinusoidal signal

IEC 60898-1 and IEC 60947-2: What are the main differences of both standards?

Florian Krackhecke: *Product Marketing Manager DIN Rail Products - ABB*

Both Standards apply to circuit breakers according to their definition. The main limitation of IEC 60947-2 is the voltage level 1.000 V a.c. and 1.500 V d.c. On the other hand, the limitation of IEC 60898-1 is much more precise and strict: this standard applies to circuit-breakers with a maximum voltage of 440 V a.c. between phases, a maximum rated current of 125 A and rated short-circuit capacity not exceeding 25 kA. IEC 60947-2 "applies whatever the rated currents, the method of construction [of the breaker] or the proposed applications of the circuit-breakers may be." IEC 60898-1 describes the application like following: "circuit-breakers are intended for the protection against overcurrents of wiring installations of buildings and similar applications".



IEC 60898-1: Usability for uninstructed people

Overcurrent is defined as a current which is exceeding the rated current and could be divided into overload current and short-circuit current.

Another big difference is that IEC 60898-1 describes also the usability of circuit-breakers for uninstructed people. This description is not done inside the IEC 60947-2 and is not stipulated.





Environmental sensitivity and energy saving

Transportation and logistics with zero impact in the new headquarters in Cuneo

Maurizio Gambini: *Journalist* - Paolo Mellano: *Sales manager ABB branch - Turin*

Logistics and transportation company of Cuneo (Madonna dell'Olmo locality) founded in 1975, Nord Ovest operates for 35 years at an international level. Equipped with warehouses for the reception of the goods and the subsequent shipment, the Piedmont company supports the customers also taking care of all the document aspects inherent to shipments entering and leaving the country.

The new directional centre has been realised according to innovative home automation and energy efficiency concepts and is operational since approximately one year. The strength of the shipping company is all in the skills and the services of the employees.

"We have always invested in the people, the true motor of the company", explains

Giovanni Battista Mellano, one of the owners, "and that is why over the course of the last years we have created this new structure, trying to render it as welcoming as possible, an ideal workplace for those who work inside".

To make working in the company even more comfortable a relax zone has been created, with an equipped gym area, a squash court, showers and lunch room, that the employees can use before or after the working hours and during the break. Attentions that usually only the large companies have towards their staff and which the Piedmont company, even though it is relatively small (50 employees), wanted to do.

Making the working atmosphere even more pleasant are the technologically advanced systems, designed and realised with an environmental sensitivity.



01

“We are a zero impact company: for example, we are not connected to the gas network; our energy reserve is nothing else than a water tank which allows us to produce warm water for the heating and the services, by means of a geothermal system with heat pumps, and to distribute the cold water for the environmental conditioning. The heating is underneath the pavement whilst the cooling is supplied by ceiling radiating panel. A solution allows us to have a comfortable atmosphere, with the correct temperature, both in the summer, as well as in winter, which is particularly cold in this area.

Moreover, we produce approximately 200 kW of electric power through a photovoltaic system installed on the roof of our warehouses, energy that we partially use and partly sell to the utility”.

Automation and control

The owners had the necessity of being able to manage all of the systems from a single interface, easily controllable at a distance as well. It was opted, therefore, for an intelligent system for the control and the automation of the building, using ABB i-bus® KNX products.

“We started from a very wide vision during the design phase of the system”, specifies the designer, Mario Pregliasco. “The requirement was to have a zero impact company, where it was also possible to work well. These basic considerations have pushed us towards a philosophy of intelligent automation of the building. On one side we wanted the maximum selectivity from an electrotechnical point of view; in the sense that if a problem arose, the relative consequences had to be as limited as



- 01 The technologically advanced systems are managed by a single interface, which can also be easily remote controlled
- 02 The relax zone with equipped gym zone which employees can use before or after work or during the lunch break

02

F2C-ARI



Autoreclosing units have been used in the electric panels, fundamental in order to ensure operational continuity in case of unwanted tripping of the RCCB caused by lightning or electrical disturbances. Following the RCCB tripping, F2C-ARI carries out three attempts to automatically reclose. The F2C-ARI device for industrial use can reclose the 2 and 4 poles RCCB of every sensitivity with rated current up to 100 A.

possible, thanks to a hierarchical system of protection. On the other an effective management was necessary, simple and complete because, within a company like this, it is not easy for those not specifically assigned to the work to be able to have everything under control and it is not even thinkable to dedicate only one person to such a task. For this we have thought of a building automation type solution, which embraced the various systems, from the real system to the lighting system. Manual switches are replaced by combined presence and lighting detectors that, based on the presence of the persons in the premises, switch the lights on and off and regulate these in function of the external brightness, an advantage for energy saving and comfort. From fire prevention to thermoregulation, to environmental well-being, to the access control, to the acquisition

of the data of the production of photovoltaic energy, everything has been engineered for efficiency and comfort. One of the main elements that have allowed us to conclude this project with success is the trust given to us by the customer, who has fully embraced this philosophy”.

The photovoltaic system

As we have already said, the photovoltaic system has been realised on the roof of the warehouse, whilst the switchboards, inverter and the MV/LV transformer are situated on its inside.

“The roof of the warehouse”, illustrates Mario Pregliasco, “was not suitable for a coplanar installation, therefore we have had to study specific structures to position the modules, so that they could have an optimal exposure to the light.



The bidirectional connection in medium voltage at the delivery point is realised with a buried cable”.

Service redundancy and continuity

The pulsing heart of a company like Nord Ovest is the room where the server of the computer system is housed.

“A large part of the company’s work”, confirms Giovanni Battista Mellano, “is based on the data, the connections with the customers. This is the reason why we have invested a lot in hardware and software, but also on the technological systems that has to guarantee the operation under all circumstances: it would be a disaster if we were left without power».

This is the reason why the server room was constructed with particular details, in order to guarantee the operational continuity. “Even if it is very improbable, we had to consider the hypothesis that a photovoltaic module was damaged or a string broke down, at the same time as a network drop”, specifies Mario Pregliasco. “Taking advantage of the functionalities of

the building automation system, we have been able to realise a complete structure, with doubled circuits, in which the gen set, the UPS and the photovoltaic system are integrated, in order to guarantee the continuity of the electric power supply. It is within this philosophy that automatic self-reclosing switches have been used in the electric panels, fundamental in order to avoid unwanted trippings provoked by thunderstorms or electrical disturbances.

For that regarding the communications, operational continuity has guided the project. We are connected with fibre optic to a telecom central, whilst a copper line, connected to another central, always ensures the service in case the first breaks down.

In other words, we have paid the maximum attention to the redundancy of the systems, perhaps influenced by a common passion, mine and of that to the owner, for scuba diving, where nothing can be left to chance”.



03

03 Dr. Giovanni Battista Mellano, owner of Nord Ovest is concerned with providing services in the field of international forwarding and customs operations

ABB, not only products

“The choice of ABB products”, concludes Ivo Panero, of Domotica Labs, who has handled the programming of the building automation system, “was born from the common consideration made by professionals that have cooperated in the realisation of the system, that ABB is both a high reliability brand on the electrotechnical plan and, at the same time, offers of a wide and complete range of products for the electrical distribution and the automation of the building, easy to install, to program and to use, and which allowed us to trust building automation systems, thanks to the Konnex protocol. Moreover, ABB does not only supply the products, but has also contributed with its own experience, offering us precious technical consultancy for the good setup of the system».

A realisation which was certainly not easy, completed with the full satisfaction of the expectations of the customer thanks to the team work of the designer Mario Pregliasco, the installer Nino Dalmasso, software manager Ivo Panero and the Cuneo branch of IDG.

The final result has been a technologically advanced system managed as a simple one, taking advantage of an “easy to use” interface software.

Professionals

Electric consultant

Studio Pregliasco Mario
Mondovi, CN

Electric installation

D & M sas di Dalmasso A. e Meineri A. & C
Peveragno, CN

Building automation system project

Domotica Labs
Ing. Ivo Panero
Genola, CN

Electric wholesaler

IDG S.p.a. branch of Cuneo
Referent Mr. Emilio Pettiti

Sales manager ABB branch - Turin

Paolo Mellano



A world without electricity

An imaginative and unsettling picture to think of the future with seriousness and commitment.

Roberto Vanetti: *Product Marketing Manager DIN Rail Products - ABB*

Often we do not notice how much we became dependent on electricity, just how much this is present in our normal activities. If we woke up one day and found that electricity had disappeared, what would our world look like, and our daily life? Let's try to figure it out.

Many people would probably stay in bed till late that day, because they use electronic alarm clocks or the mobile (maybe even charging during the night before) to wake up. Another sensation that many would suffer is an unpleasant climate: if it's summer, hot, because the conditioning systems can not be turned on; if winter, cold, because the heating systems would not work.

And then the first practical problems, even though we've only arrived at the kitchen: the freezer loses water because the ice melts, the cooker can not be turned on, the microwave doesn't work. Clearly, all of this would be in the dark.

At the beginning we would behave like in the case of a simple black out, with some portable battery powered lamps and some candles, which would end quite soon, without considering all the people that would remain blocked in lifts, undergrounds, trains, without being able to call anybody, neither with alarms, telephones, because everything is now dependent on electric power.

It would be difficult to understand what has happened, since our sources

of information are all intrinsically linked to electricity. Television, radio, Internet and telephone would not work and neither would we have any help from the newspapers: these would not be available because they are printed with electronic machines.

And don't expect to rely on mobile phones; the mobile phone, even if charged, would not help us since the network and its telephone central must be fed with electricity.

All of our current globalisation would be missing, it would be difficult to get into contact with persons in the same city or those close by and it would be difficult to think about getting into contact with persons further away, in other states and continents. People would begin to feel lost after a couple of hours.

The more obvious thing would be to go out, to go to the Police, relatives and friends, to try and get some kind of explanation. Would it be possible to go by car? Certainly, but only until your full tank lasts, because then the gas stations, with their electric pumps, would not work anymore. And obviously, during the night there would be no street lighting or traffic light signals.

The accessible petrol resources would be very limited and, in any case, exhaustible in a short time, given the impossibility of having any industry for the refining. Hospitals would have enormous problems when the stock for the diesel generators is finished - the current would not be available with the consequent impossibility of assisting thousands of people dependent on the electronic machinery.





The run on the supermarkets would begin where many products would be unusable, because they are in the refrigerators which are now switched off. And paying would not be simple given that the bills are often electronic. The value of the money, as we know it would cease to be as we know, as it would no longer be possible to print it with the same techniques.

The situation which would evolve over the days can be just imagined: to use the word 'evolve' would already be inopportune because in reality it would be a total reversal of the growth trend of our society, a real barbarization and a return to the nearly medieval state. The majority of current employments would no longer be possible with the almost total disappearance of all the employees. There would be a rush towards the handicraft professions, even if currently even those are strongly influenced by electric/electronic machinery. A return to the countryside in some way to find enough food is not improbable with the consequent slow, but inexorable, transformation of our society.

And then the worst of the disasters: we would not even be able to let you read Day by DIN anymore!

Some thoughts

Don't be afraid, this is pure science fiction! Nuclear, thermoelectric (oil, gas or coal), hydroelectric, geothermal, wind, solar and other technologies still offer enormous potential for energy production, allowing us to live in the world as we now see it, with the pervasive presence of electricity in all the human activities, as we have already noted previously.

Our planet is very rich in resources for energy production, but these are not infinite, besides from not having a uniform distribution. Unfortunately, this knowledge has only been gained over the last decades and we have wasted a lot during the preceding periods.

The imaginative (and at times, alarming) story is meant as a stimulus to reflecting on the availability of current energy. Because, even though an energy source can be clean, economic and renewable,

it will always have an environmental cost (landscape, production, system) whilst the only true clean energy is that which we can all "produce" through our daily saving. Each one of us can help by adding lots of small drops into the sea of energy saving; this sea will be one of the many that will, in future, contribute to forming the great ocean of clean energy production.



Roberto Vanetti
Product Marketing Manager
DIN Rail Products
ABB

A short look at the meaning of lightning through the ages

Lightning, in ancient civilization, was commonly seen as a symbol of punishment of humans by the gods. In many mythologies too, the thunderbolt plays a role as a weapon of destruction. In India, for example, the king of the Gods, Indra, used the Vraja (thunderbolt) to kill his enemies.

According to Chinese mythology, lightning is the consequence of the conflict between the yin and the yang, just like sparks caused by friction between two materials. The most important divinity in Chinese mythology was Lei-Tsu, the Ancestor of Thunder; he was represented with Lei-Kung, Duke of Thunder, and Tien-Mu, Mother of Lightning. Tien-Mu, represented as a female figure, controlled lightning by holding in either hand a mirror from which she emitted flashes of light.

In ancient Japanese Buddhism, Fudo Myo-o, one of five 'wisdom Kings' is represented holding a thunderbolt sword in his right hand that he used to defeat demons.

If we come back to Europe, in Slavic mythology, Perun was the thunder and

lightning god. In Norse and Germanic civilization, Thor, symbol of power, was the God of Thunder. He was portrayed as a tall and powerful man with a red beard and eyes of lightning. Despite his ferocious appearance, he was very popular as the protector of the gods and humans against the forces of evil. And, of course Zeus, the 'Father of Gods and Men' for the ancient Greeks, held the lightning stone in his right hand.

More recently, eighteenth-century research and experiments done on electricity by Benjamin Franklin and the abbot Nollet tried to recreate lightning sparks to improve knowledge in electricity theory. The experimentation led to a large interest into external lightning protection.

Nowadays, ABB with its Lightning Protection Group at the Pic du Midi, close to Bagnères de Bigorre in the south west of France, continues these in-situ experimental tests on external lightning protection and surge protective devices. With its OPR lightning rods and OVR surge protective devices, ABB can offer a reliable and safe surge and lightning protection.



Christophe Rios
Product Marketing Manager
DIN Rail Products
ABB



Lightning Protection Group at the Pic du Midi, close to Bagnères de Bigorre in the south west of France

Electric power and modernity: new scenarios, new possibilities

When the cheers increase, consumption decreases

Television and electricity: just how these two elements intersect is very interesting. Not only for the obvious connection due to the operation of the first by means of the second, but also for the variation in consumption, on a national scale, in relation to TV programming. A really interesting example is from the 4th of July 2006: a special event is programmed, the world cup semifinal 2006, Italy -Germany which

was won by the Azzurri. During the match the national consumption went down in Italy to 2.500 MW, thanks to the number of meeting places and the habit of watching the match with the lights out. The non-consumed value is equal to that normally used for supplying an immense city such as Rome for a number of hours. A really big... saving!



580 km of technology and collaboration

The longest submarine cable for the transport of electric power in the world runs between the city of Feda in Norway and the port of Eemshaven, in the Netherlands. The line runs for 580 km and was built by ABB with highly innovative technology and solutions. The cable allows Norway to export "clean" electric power, produced solely by hydroelectric power plants, thus enabling Holland to lower its own amount of CO₂ emitted. The cable moreover has a bidirectional function meaning that, in the case of an energy emergency, Norway imports the required power from Holland. The technical characteristics of the cable

are particularly interesting: two conductors, isolated each other by means of cellulose soaked with oil, with a direct voltage at ± 450 kV and very limited dispersions of about 3.7% of the current transported. Moreover, because of the particular type of sandy 'dune' beds found in the first section from Holland, very high mechanical performances were foreseen, able to resist the powerful stress caused by the continuous movements of the seabed.



Flying with solar energy: learning from wasps

An airplane fed by solar energy through panels on the fuselage is still far away from perfection by man, not for the animal world. Israeli researchers have, in fact, discovered that the *vespa orientalis*, an insect which is, among other things, present in Europe southern regions, takes advantage of a sort of photovoltaic solar paddle in order to obtain electricity, to then use it for functions connected to the metabolism such as, for example, the search for food. This panel is constituted of a band of yellow on the abdomen, in a part composed of xanthoferina, a pigment that allows the

conversion of solar into electric energy. Nature does nothing by chance and the presence of this particular pigment, in fact, influences the structure of the entire body, which is formed in such a way as to concentrate the solar beams where they serve. This study could lead to a number of innovations in the field of renewable energy as well: the researchers have, in fact, created a photovoltaic cell with the same substance, successfully obtaining the conversion of solar light into electric power, even if the yield is very low for the time being.



Continuity of supply

ABB APR high-immunity residual current devices offer excellent protection against unwanted tripping

Claudio Amadori: R&D - ABB

Unwanted tripping of an RCD is when this occurs in the absence of a real fault or dangerous situation for people and property. Unwanted tripping always constitutes inconvenience and economic harm (e.g. due to the power failure of a refrigerator). In some cases, sudden and unnecessary power failure can actually represent a hazard due to being plunged into darkness, leading to panic and the use of flames such as candles for illumination. This is particularly critical for more vulnerable people, such as the elderly and kids.

In almost all cases, unwanted tripping can be traced back to current leaking to earth which is not due to any identifiable fault, which the RCD interprets as a residual current. These leakage currents can be permanent or impulsive, or more often a combination of both. Typical causes of impulsive leakage currents, are overvoltages on the mains electrical supply network.

The overvoltages are due to atmospheric phenomena, switching on the grid carried out by the electricity distributor, by large industrial customers in the area (also building construction sites) or by devices inside the user system itself.

Atmospheric overvoltages are caused by indirect lightning strikes on power lines causing an impulsive surge on them which is added to the normal grid voltage. (Figure 1)

01 Atmospheric overvoltages are caused by indirect lightning strikes on power lines



Switching overvoltages are caused by connection or disconnection of inductive loads such as motors, transformers and fluorescent lighting ballasts, as well as operations performed on the electrical grid itself. (Figure 2)

Sudden unwanted trippings of RCDs, apparently without any reason, are usually to be attributed to switching on the network. Above all, if these are repeated at the same time of the day they are indicative of daily switching performed on the network by a nearby user or the electricity distributor.

Preventing unwanted trippings

The ABB APR range is the best solution to prevent unwanted trippings. These RCDs, aside from satisfying the functional and safety requirements of current product Standards (IEC/EN 61008, IEC/EN 61009), are particularly immune from unwanted tripping thanks to the following additional features.

Impulse current withstand 8-20 μ s

ABB APR RCDs don't trip for impulsive leakage currents with the standardized 8-20 μ s waveform up to a peak value of 3000A, which represents the current impulses associated with overvoltages on the electrical network originating from indirect lightning strikes (and in general representing all intense impulses of a limited duration). (Figure 3)

02 Switching surges are caused by connection or disconnection of inductive loads such as motors, transformers and fluorescent lighting ballasts as well as operations performed on the electrical grid itself

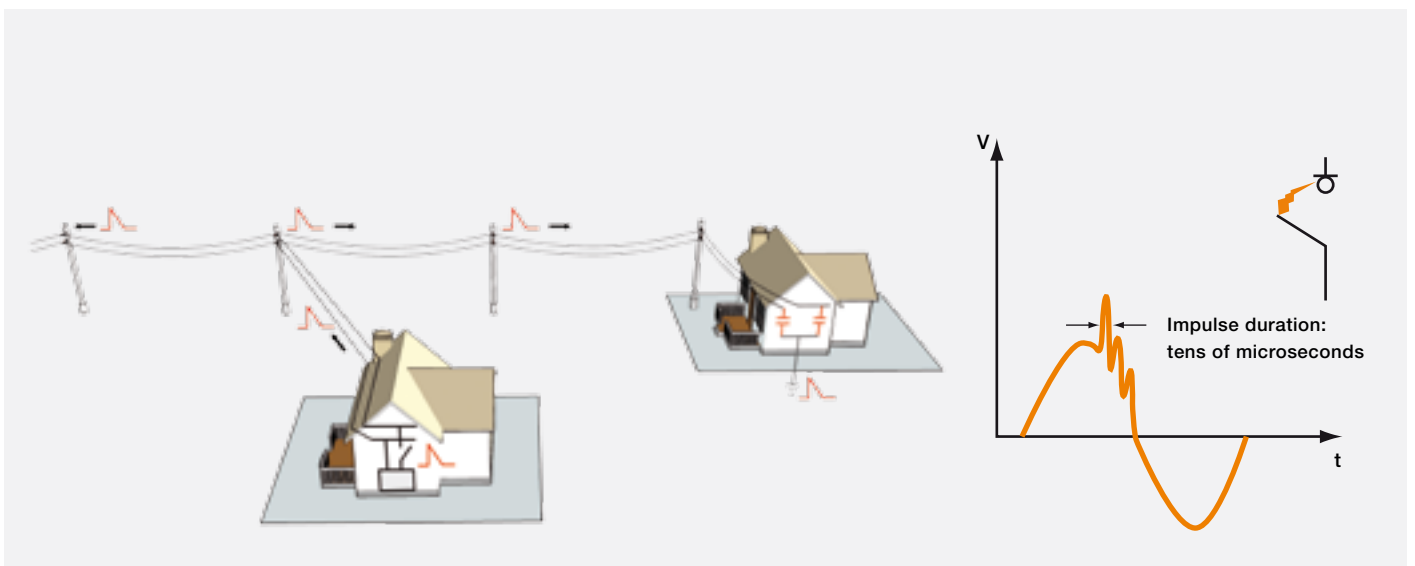

Immunity to short time leakage currents (temporal filtering effect)

APR RCDs do not trip with residual currents of a maximum duration of 10 ms, such as inrush currents, connection / disconnection currents etc., including those in the presence of electronic loads fitted with filters. (Figure 4)

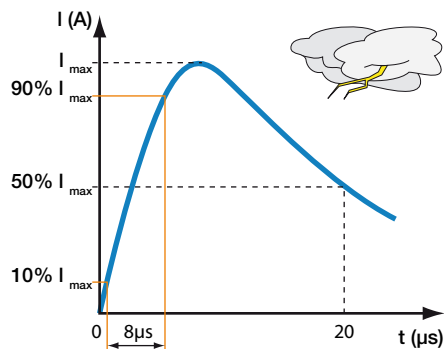

Immunity to high frequency leakage currents (low-pass filter effect)

The sensitivity of the APR RCDs decrease with the increase of the frequency of the leakage currents components, such as harmonics generated by some electronic devices. The APR RCDs guarantee the maximum level of safety according to the IEC 60479-2 requirements for the protection of people in function of the current frequency. (Figure 5)

In addition to these three special features of the APR devices, they also pass the ring wave test (0,5us/ 100kHz), required for all RCDs by IEC/EN 61008 and IEC/EN 61009 up to the peak value of 200 A (or 25 A if $I_{\Delta n} \leq 10 \text{ mA}$). This test guarantees immunity to small switching overvoltages which are normally present in any system. (Figure 6)

Total protection

In practice, APR high-immunity RCDs are able to avoid any unwanted tripping with impulsive origins. They are also effective in the case of permanent or inrush leakages caused, for example, by electrical filters on devices such as inverters, IT equipment or lamps' electronic ballasts.

03

- 03 Standardized waveform impulsive residual current 8-20 μs
- 04 Intervention and non-intervention time for APR RCD devices
- 05 The intervention threshold for APR devices is below the danger level for high-frequency currents

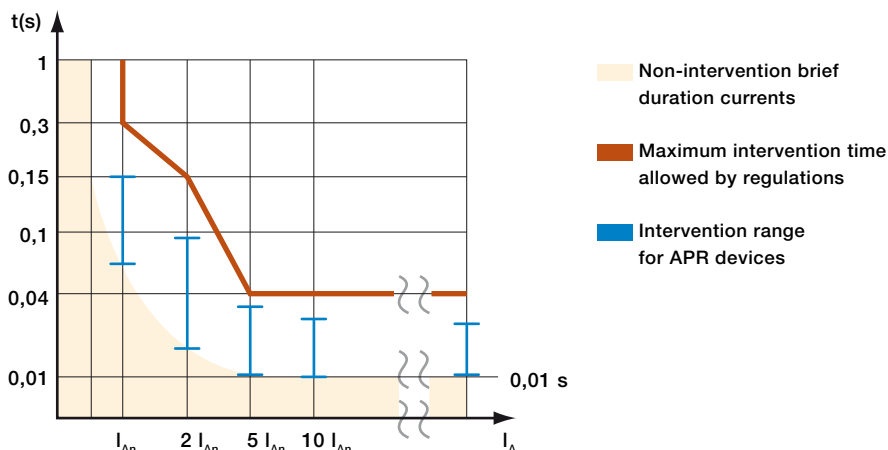

04

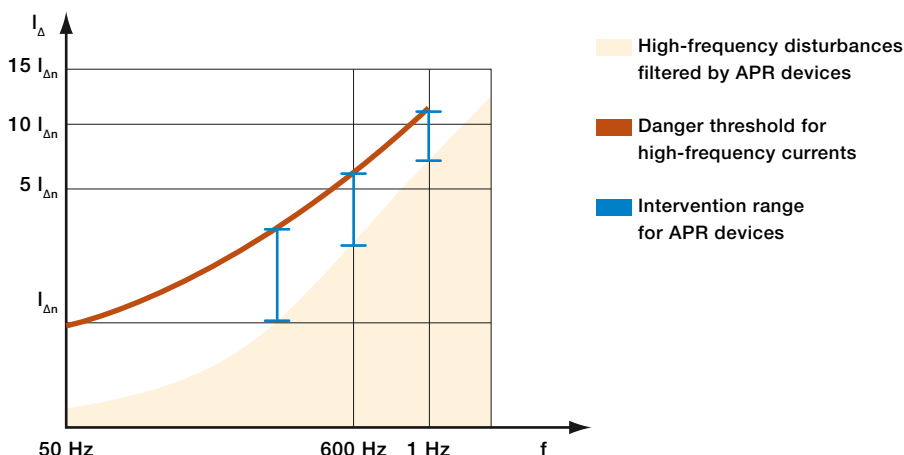

05

This is due both to the frequency filter effect and the fact the RCDs are usually tripped by a transitory contribution to the leakage – due, for example, to equipment being connected – which combines with the permanent leakage. In any case, in the presence of very high permanent leakages, maximum operational continuity is obtained by dividing the loads between multiple APR high-immunity RCDs. The APR series devices allow the number of loads supplied by the same RCD to be increased without provoking unwanted tripping. (Figure 7)

When to use APR high-immunity RCDs

APR high-immunity RCDs should be installed whenever unwanted tripping needs to be avoided.

Substantially, there are two such circumstances. The first is when system and load conditions make the probability of disturbances, which could cause unwanted tripping, particularly high. This is the case with:

- Powering electronic loads, particularly if they are fitted with inverters and electrical filters, lights with electronic power supplies, dimmers etc.
- Suburban areas, isolated buildings, overhead power supplies, proximity to factories or construction sites, areas subject to thunderstorms (in these cases it is also necessary to provide for surge protection using suitable SPDs).

The second occurs when operational continuity is particularly essential, like in the following cases:

- Hospitals, emergency services;
- Intrusion alarm systems, refrigerators, freezers, electric vehicle charging systems;
- Non-supervised systems, radio base-stations, surveillance equipment;
- IT centres;
- Continuous industrial processes;
- etc.

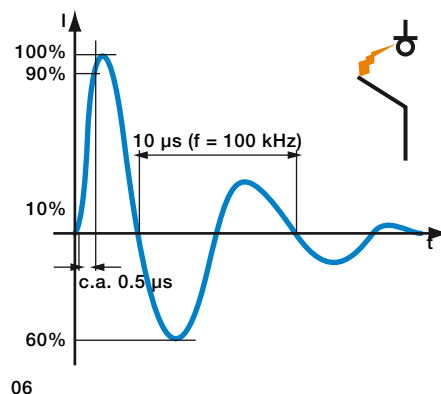

06

06 0.5 μs/100 kHz test damped oscillating residual current (ring wave)

07 In the presence of very high permanent leakages, maximum operational continuity is obtained by dividing the loads between multiple APR high-immunity RCDs. So the number of loads supplied by the same RCD can be increased without provoking unwanted tripping

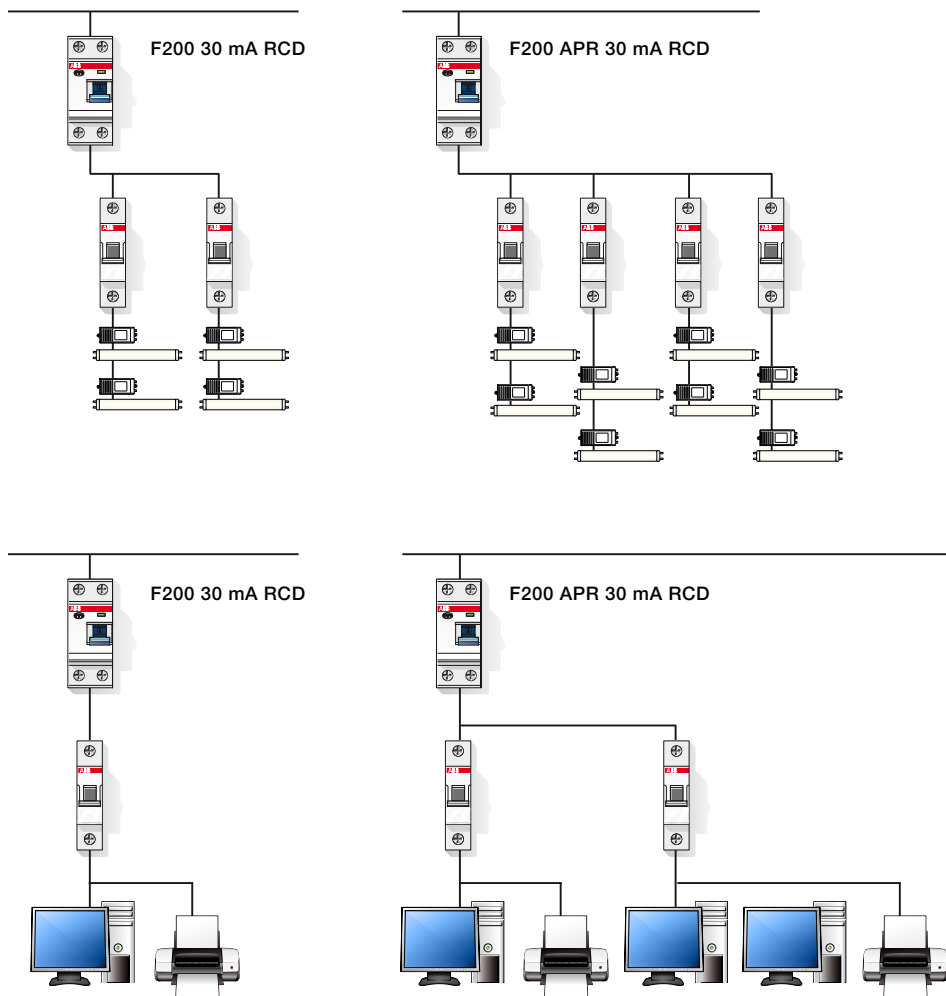

DS202C M APR

ABB offers RCCBs and RCBOs APR version with greater protection against unwanted trippings due to overvoltages generated, for example, by lightning strikes, switching on the grid and other disturbances.

A real success story:
started in 1891 and patented in 1924





The history of our MCBs started in 1891. A real pioneer named Hugo Stotz founded a family business in Mannheim (Germany) in 1891 specialized in installation work in the growing field of electric lighting. Company founder Hugo Stotz saw the need for a circuit breaking device which could be re-closed multiple times without replacement or dismantling.

Florian Krackhecke: *Product Marketing Manager DIN Rail Products - ABB*

In 1923, Hugo Stotz combined a thermal and a magnetic trip unit in a single device.

In 1923 he started to develop an automatic fuse using electric sensors and mechanical actors to break the circuit in case of a fault instead of melting down a wire. In 1924 he was granted a patent for his invention and launched the circuit-breaker onto the market in 1928 under the brand-name STOTZ-Automat. Today his invention, which consists of a thermal and an electromagnetic tripping device, is known as a miniature circuit breaker (MCB).

The first miniature circuit breaker was a resounding success, as it could simply be screwed into fuse sockets.

In 1928, the first year of MCB production, STOTZ also developed an MCB with K characteristic, designed especially for motor applications.

At the 1957 Hannover Fair the new STOTZ MCB outstripped the competition with an MCB that had a shorter switching time combined with the ability to break a 10 kA short-circuit current. This was possible due to the hammer trip and other new constructional improvements.

1970: a standardized holding system was introduced – today known as DIN Rail.

In 1970 the DIN rail was introduced and, from the very start, STOTZ was able to provide MCBs for the new standardized holding system.

The first selective MCB worldwide was introduced in 1980, which made it possible to set up selective cascades within pure MCB cascaded protection systems. Up to the launch of the S700 MCB, selectivity was only provided by fuse systems.

Since 1999 ABB STOTZ-KONTAKT has been producing the System proM compact – S200 range.

And the success story continues today.

ABB STOTZ-KONTAKT GmbH is an attractive and profitable company with around 1,500 employees developing, manufacturing and selling highly modern modular systems for electrical building installations, products for electrical energy distribution, for machinery and factory automation as well as sensors. We help our customers to improve their productivity and performance, save energy and reduce their environmental impact.

And where do we go from here? We do not know, but MCBs from ABB STOTZ-KONTAKT will definitely be in the forefront.

ABB STOTZ-KONTAKT – changing with the times

What else did STOTZ produce in the past?

Everybody knows that miniature circuit breakers, contactors, building automation products and manual motor starters are part of the product portfolio. But what is still not known well: Stotz produced electrical irons in the twenties. At this time it was much more known to use irons heated with coal.

Later, during the fifties, STOTZ produced sockets and plugs made of wood; due to lack of materials after world-war two. Also for the B2C business STOTZ produced electrical ovens and stoves.

All the mentioned products and many more, eg. silverware or table lamps, could be seen during a visit of the HUGO STOTZ museum in Heidelberg, Germany. You're much more than welcome!

1891

120 years young



1923

88 years of miniature circuit breakers



1932

79 years of licensing alliances



History

- | | | |
|--|---|--|
| <p>1891 Company Founding of Moyé und Stotz, electrical installations</p> <p>1896 Moyé retires and the company is renamed Stotz und Cie. Elektrizitätsgesellschaft mbH</p> <p>1912 Subsidiaries in Freiburg, Karlsruhe, Worms, Schlettstadt, Heidelberg, Pirmasens, Wiesloch, Stuttgart and Kaiserslautern, employing 300 fitters. Installation division sold to BBC, company renamed to become Stotz und Cie. GmbH, Fabrik elektrischer Spezialapparate. Manufacturing plant constructed in Mannheim-Neckarau</p> <p>1918 Stotz und Cie. becomes a subsidiary of BBC</p> | <p>1923 Development of automatic circuit breaker for protection against electrical overloads and short circuits</p> <p>1928 First year of S 11 miniature circuit breakers production - a model produced until 1950</p> <p>1930 Manufacturing of contactor relays starts. Stotz GmbH merges with Kontakt AG, Frankfurt to become Stotz-Kontakt GmbH</p> <p>1935 The manufacture of explosion-proof devices starts</p> <p>1939 Fire at the warehouse in Neckarau. Decision made to build a new factory in Heidelberg</p> | <p>1940 Subsidiary plant set up in Eberbach to manufacture aviation components</p> <p>1943 Assembly of miniature circuit breakers, rotary and flip switches and power outlets commences in Heidelberg. The process equipment manufacturing division also relocates. Mannheim factory destroyed in an air raid</p> <p>1948 First year of S 111 screw-in miniature circuit breaker production</p> <p>1964 The Waibstadt production site opens for final assembling activities until 1975</p> |
|--|---|--|



Florian Krackhecke
Product Marketing Manager
DIN Rail Products
ABB

1961

50 years of modular technology



1985

26 years of highly mechanized S2 manufacture



2012

Launch of the new System pro M compact



1968 Introduction of mechanized production facilities for manufacturing and assembling components

1969 Acquisition of the electrical division of Busch-Jaeger, Dürener Metallwerke AG, Lüdenscheid and founding of Busch-Jaeger Elektro GmbH

1970 First STOTZ circuit breaker with a width of 17.5 mm and a mounting height of 68 mm

1974 Safety technology division established

1974 New factory set up in Eppelheim for manufacturing, construction and training

1978 Acquisition of "Electronic devices" division (incorporated into business area automation technology in 1982)

1980 First Stotz main circuit breaker

1981 Finished goods stock consolidated into Walldorf distribution center

1983 Development and production of the SIGMA® i-BUS system at the Walldorf plant

1985 First semi-automated production of miniature circuit breakers

1989 Following the founding of Asea Brown Boveri (ABB) in 1988, activities are assigned as follows:

- "Explosion-proof devices" to ABB CEAG GmbH
- "Switching devices" (formerly process equipment manufacturing) to ABB Schalt- und Steuerungstechnik GmbH
- "Safety technology" to ABB Installationen GmbH

1991 System pro M compact® with uniform design (red bar)

1991 Anniversary year with the motto: "100 years young"

2002 Integration of Entrelec Germany, electronics manufacturing in Hornberg

2010 Integration of Jokab Safety Germany

Surge and lightning protection standard IEC / EN 62305 -1/ -2/ -3/ -4:2010

Christophe Rios: *Product Marketing Manager DIN Rail Products - ABB*

The new IEC / EN 62305:2010 is now the main installation standard for lightning and surge protection. Compiled into four parts, it takes account of varied aspects of the structure and it's content to offer a complete lightning and surge protection to the structure and electrical equipments:

- **IEC 62305-1:** Part 1 provides the general principles to be followed in the protection against lightning of structure, including their installations and contents as well as persons, and services connected to a structure;
- **IEC 62305-2:** Part 2 is applicable to risk assessment for a structure or for a service to due lightning flashes. It provides a procedure for the evaluation of such a risk;
- **IEC 62305-3:** Part 3, this part deals with the protection, in and around a structure, and against physical damage;

- **IEC 62305-4:** Part 4 provides information for electrical and electronic system within structure.

The IEC 62305-1 introduce the idea of a complete Lightning Protection (LP), which consists in both external and internal lightning and surge protection.

Considering external lightning protection system (LPS), it consists mainly in protecting a building against direct lightning flashes with different system, i.e. external lightning rod on the roof of a Building (Figure 1).

When talking to internal surge protection measures (SPM), it consists in installing surge protective devices (SPDs) that can be fixed at the main entrance of an electrical system, i.e. Type 1 and Type 2 SPDs in a distribution board to protect sensitive equipment like computers in a house (Figure 2).

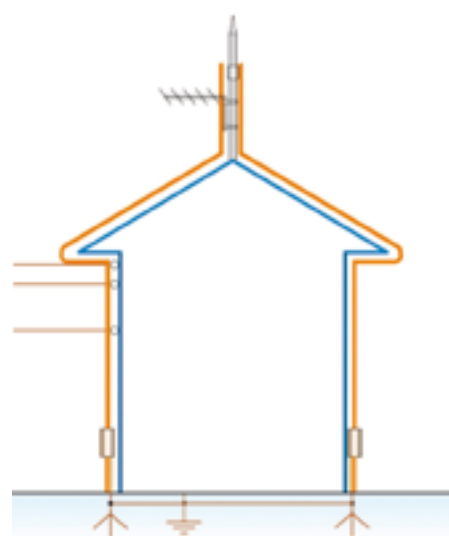

01

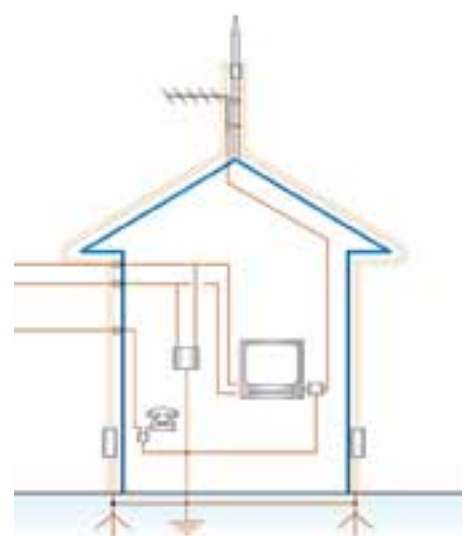

02



Christophe Rios
Product Marketing Manager
DIN Rail Products
ABB

The IEC 62305 defines four sources of damage S1, S2, S3 and S4, each of them depending on the different points of strike of lightning, for which a type a damage is assigned (D1: injury to living being; D2: physical damage; D3: failure of the electrical system). Thus, according to the risk assessment (IEC 62305-2), the following protection measures can be proposed to reduce the lightning and surge risk, either the LPS and/or SPM.





As explained in the standard, it can be summarized as below:

SPD installation:

For all sources of damage (S1, S2, S3 and S4) and, if the distance from the SPD to the equipment to be protected is over 10m, electrical oscillations can lead to a huge increase in voltage at the final equipment location.

Furthermore, especially in case of S1 and S2, magnetic coupling can generate surges inside the building itself which are not treated by the main SPD installed in the main distribution board for instance.

To avoid this, it is highly recommended to install SPDs as closer as possible from the equipment. This can be done in implementing stepping protection with installation of Type 1 in the main distribution board, Type 2 in the sub-distribution board or final enclosure and eventually Type 3 by the equipment including date-lines protection.

Point of strike		Source of damage	Type of damage	Protection measures	Protection selection (minimum)
Structure		S1	D1 D2 D3	LPS + SPM	External + SPDs T1
Near a structure		S2	D3	SPM	SPDs T2
Service connected to the structure		S3	D1 D2 D3	LPS + SPM	External + SPDs T1
Near a service		S4	D3	SPM	SPDs T2



SMISLINE TP – Power and safety

An electrical system must meet all the requirements for planning, design and maintenance throughout its entire life cycle. With systems that are operating all the time, the problem often arises that extensions or modifications need to be carried out whilst the system is live. Working on live systems is basically possible, but in practice this involves a considerable number of (safety) measures.

A touch-proof socket system that allows load-free working under live conditions without personal protective equipment would be the best solution. This can crucially reduce the costs during the entire life cycle of a system, whilst at the same time offering increased protection for personnel.

Malvin Lingwood: *Product Marketing Manager DIN Rail Products - ABB*

A progressive solution should not only be technically sound but must also be viable in day-to-day operation. In our fast-moving world, in which technology changes at such a rapid rate, we need solutions that work in the long term.

Loss of Power is a risk factor for human, electrical process and electrical equipment. Energy must today be available all the time. The security and prevention of human is very important and the technical stuff has to follow the regulations and laws.

There are systems available which allow the devices to be plugged and unplugged load free under power without any risk from electrical current running through the body. This should be confirmed by the German Employers' Liability Insurance Association or electrosuisse.

Safety when working with live equipment

Those pluggable systems should be designed in such a way that changes or extensions to the system can be carried out during operation. Today in many systems or buildings, it is not easy to interrupt the power supply to work on systems.

The touch-safe system makes this situation much easier. It allows devices and components to be plugged in and unplugged load-free live without additional personal protective equipment to protect against electrical risks.

When devices are plugged and unplugged without load, there can't be any risk of electric shock.

When the devices are plugged and unplugged, the system is fully touch-proof, means it is completely finger-safe (IP2XB).

01 Working under power



02

The advantages of the touch-proof socket system: safety, time saving, availability, flexibility

For planners, switchgear system designers and building developers, there are several good reasons for choosing a pluggable system. In buildings in which safety, availability and the capacity for extensions and modifications are a priority – e.g. in public buildings, industrial operations, safety systems such as DP, UPS in the transport sector such as airports, or telecommunications – this is an important decision.

Availability, flexibility, time saving

Long-term planning is possible without a precise knowledge of the final system, as is the problem-free re-allocation of consumers.

With a touch-proof socket system, changes can be made very easily to switchgear cabinet installations directly on site – without any additional costs, since those socket system are automatically input wired via the busbars.

There is absolutely no need for the packs of MCBs that have to be built in as back-ups and which may never be used. These can be retrofitted any time cost-effective and without any long interruptions.

A later change of use or expansion of the entire installation can be carried out quickly and with the minimum amount of work. The plug-in technology reduces the amount of mounting and wiring work required. There is no need for input and cross wiring, or for output terminals with direct outlets.

Thanks to the simplified planning and rapid construction, fitting can be carried out very quickly. The simple, fast installation, with components replaced in seconds, means that expansion is problem-free. All the devices can be added in one simple operation.

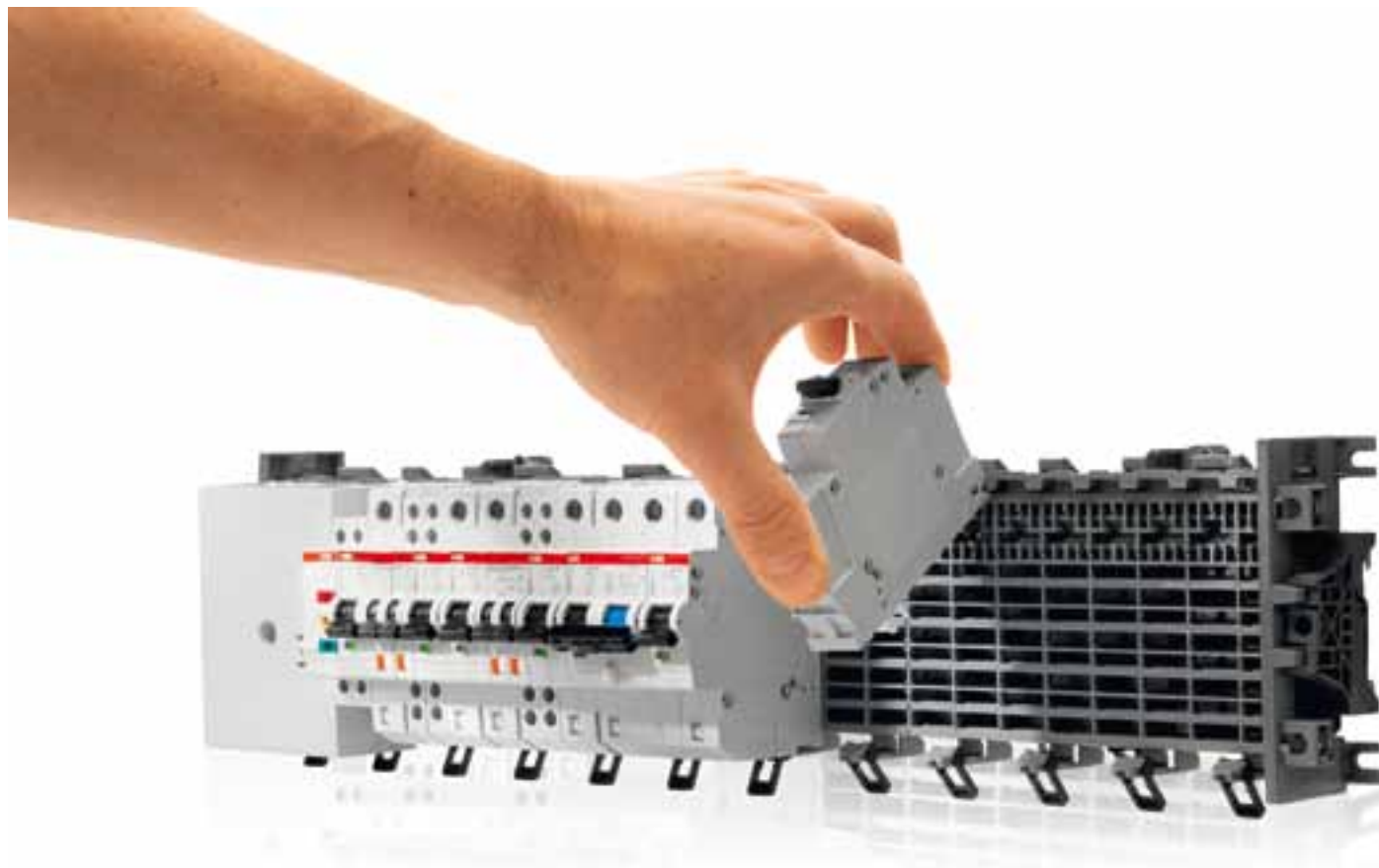

03

ABB's solution for touch-proof pluggable socket-systems: SMISLINE TP

In contrast to other busbar systems on the market, SMISLINE TP is the only system in which the devices can be touched directly – this direct plug-in capacity is what gives the socket system its considerable advantages in terms of time and safety. After the devices have been unplugged, the busbar system remains finger-safe (IP2xB). No live parts can be touched. SMISLINE has five different types of protection devices that can be plugged in directly.

These are:

- Miniature circuit-breaker S400 1-, 2-, 3- and 4-pole from 0.5 A to 63 A; B, C, D, K, UC-Z, UC-C
- Residual-current circuit-breaker F402 and F404; 25 A to 63 A, 30, 100, 300, 500 mA
- Combined RCCB-MCB 2- and four-pole to max. 10 kA FS401, FS403 in just 72mm width
- Surge arrester OVR404, 4-pole protection device type 2
- Switch disconnecter IS404 63A
- Motor protection MS325, MS116 and MS132, pluggable using adapter

- 02 Example for IP2XB protected socket system
- 03 Easy plug of devices on the system



Malvin Lingwood
 Product Marketing Manager
 DIN Rail Products
 ABB

Connect the boxes

Train your brain

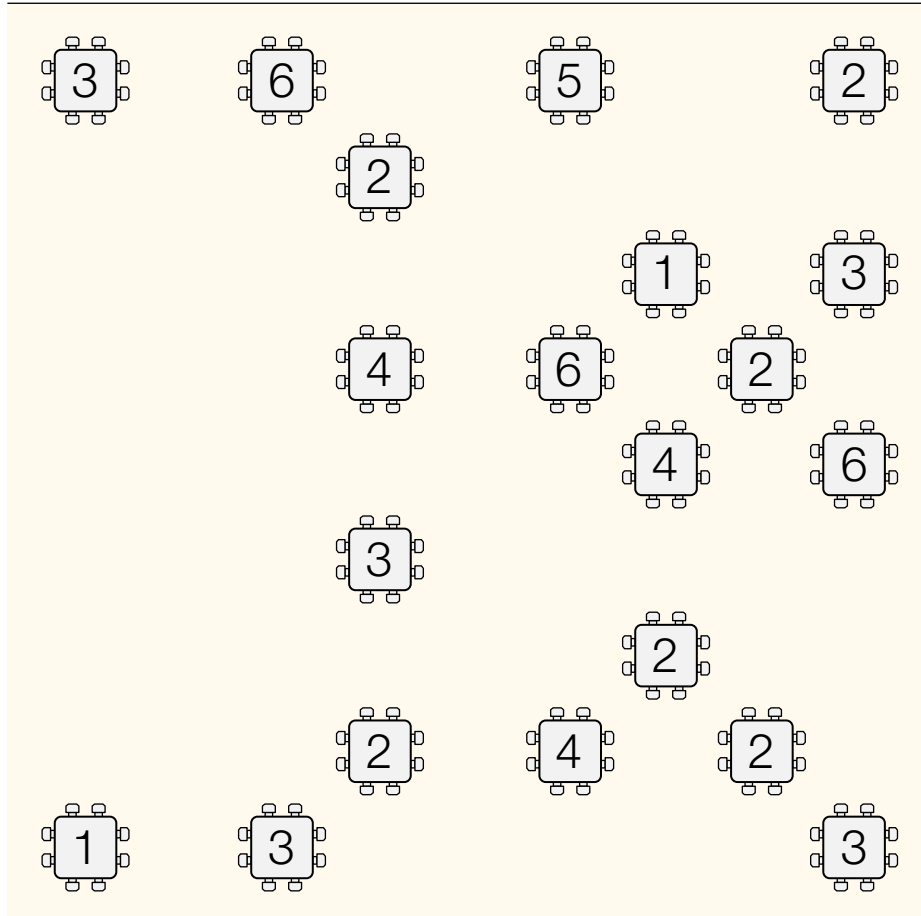

Task

You must complete an electrical system by connecting junction boxes with cable conduits.

An electrician has already installed all the junction boxes on the wall and laid down the required connections, but then he left the job unfinished without explanation.

Your task is therefore to connect all of the boxes indicated.

Instructions

- Each box must be connected to the others and the number of connections must correspond to that indicated on the box.
- Two different boxes can be connected with each other, but without exceeding two connections.
- Connections can be made either horizontally or vertically. Cross-connections are not allowed.
- There is only one correct solution and can be found purely by logical reasoning. No specific technical skills are required.

Will I be as powerful as before with the new ABB lightning protection?

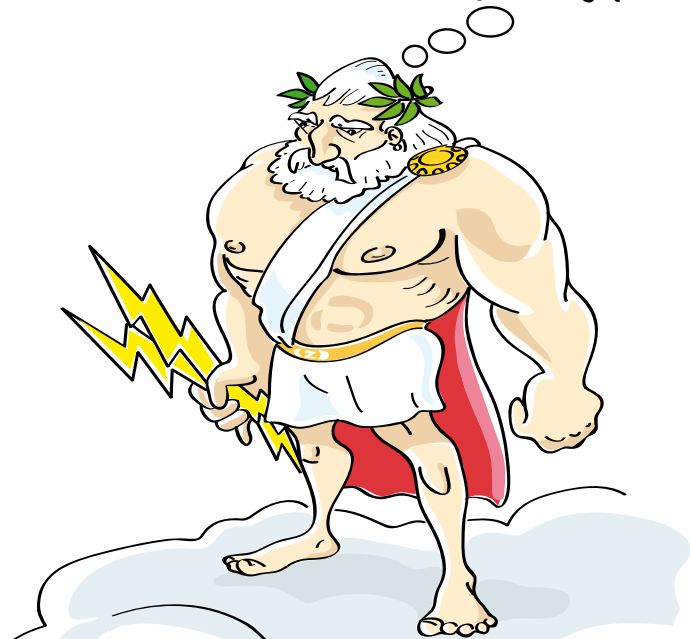

The solutions to Connect the boxes

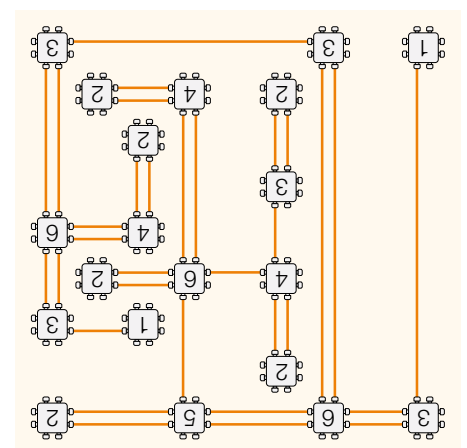



E210. Set new standards in your electrical distribution board



ABB expands E210 range with new 2 and 3 LED indicator lights. E210 allows users to save valuable space in distribution boards thanks to narrow 9 mm width. E210 range is made for consumer units, large scale switchgear, commercial buildings and industrial control systems. The new 2 and 3 LED indicator lights are ideal in alarm and status indication of loads and switches and voltage presence. The ABB range encompasses on-off, change over, group and control switches, as well as pushbuttons with and without LEDs and a variety of indicator lights. E210 meets the most important related standards EN 60669-1, EN 60669-2-4, EN 62094-1 and UL 508. www.abb.com

Power and productivity
for a better world™



Wall of fame



The international team of Day by DIN

Send photos of an application that you have realised with ABB products to the email address: mail.daybydin@abb.com
The most interesting and amusing will be published.



New DS202C. Protection with unrivalled compactness



With only 2 modules, the DS202C series of 2P residual current circuit breakers with overcurrent protection (RCBOs) enables to save 50% of switchboard space compared to the conventional 4-modules solution. Available in a technologically advanced and comprehensive range, the DS202C can be applied in the tertiary sector, in large-sized industrial plants and in naval applications. The new series perfectly integrates with the System pro *M* compact® range, starting from the same profile, ensuring a nice and functional design in the installation. The maximum protection in only 2 modules. www.abb.com



D Line time switches. Always in time to meet your needs.



An exclusive design, with a backlit white LCD display, plus an extremely ease of use thanks to the only four push-buttons and multi-language text menu formed by two lines of text, make D Line products ideal for automating the functions of the installation. Simple and intuitive programming allows D Line to easily handle the most different commands. With zero cross switching, D Line enables the switching of higher loads and extends the life of the built-in relay. D Line can also manage public holidays, which can be programmed for periods spanning different years.

www.abb.com

Power and productivity
for a better world™

