

How to Use the SKF TKSA 60 and TKSA 80 Alignment Tools



P/N 32233700-EN
Revision F

⚠ Warning! - Read this manual before using this product. Failure to follow the instructions and safety precautions in this manual can result in serious injury. Keep this manual in a safe location for future reference.

User Manual

Copyright © 2014 by SKF
All rights reserved.

2 Michaelson Square, Kirkton Campus, Livingston, UK EH54 7DP
Tel: +44 (0) 1506 470011 Fax: +44 (0) 1506 470012
Customer Service: +1 858-496-3627 or 1-800-523-7514



SKF

For additional information on SKF products, contact:

SKF (U.K.) Limited Condition Monitoring Centre (Livingston)

2 Michaelson Square, Kirkton Campus,
Livingston, UK EH54 7DP
Tel: +44 (0) 1506 470011
Fax: +44 (0) 1506 470012

Web Site: www.skf.com/cm

For technical support, contact:

TSG-Americas@skf.com (North America, South America, and Asia)

or

TSG-EMEA@skf.com for customers in EMEA region (Europe, Middle East, and Africa)

® SKF is a registered trademark of the SKF Group

All other trademarks are the property of their respective owners.

© SKF 2014

The contents of this publication are the copyright of the publisher and may not be reproduced (even extracts) unless prior written permission is granted. Every care has been taken to ensure the accuracy of the information contained in this publication but no liability can be accepted for any loss or damage whether direct, indirect or consequential arising out of the use of the information contained herein. SKF reserves the right to alter any part of this publication without prior notice.

Please take a moment to register your product at www.mapro.skf.com/register to receive exclusive benefits offered only to our registered customers, including receiving technical support, tracking your proof of ownership, and staying informed about upgrades and special offers. (Please visit our website for more details on these benefits.)

Tell us how we're doing!

It's important that you're satisfied with the quality of our product user manuals. We appreciate your feedback; if you have comments or suggestions for improvement, [please tell us how we're doing!](#)

022714js

General Notice to Users

Users are not permitted to make changes or modify the device in any way.

FCC Notice to Users

USA

Contains FCC ID: U6TZIGBIT-A2

The enclosed device complies with Part 15 of the FCC Rules. Operation is subject to the following two conditions:

(i.) this device may not cause harmful interference and (ii.) this device must accept any interference received, including interference that may cause undesired operation.

Canada

Certification Number: IC: 7036A-ZIGBITA2

Manufacturer's Name, Trade Name or Brand Name: ZIGBIT

Model Name: ATZB-24-A2

SKF USA Inc.
Limited Warranty

WARRANTY

Subject to the terms and conditions contained herein, SKF warrants to the Buyer that for the warranty period indicated below the products sold by SKF that are listed below (the "Products"), when properly installed, maintained and operated, will be free from defects in material and workmanship and shall be fit for the ordinary purposes for which the Products are designed.

BUYER'S LIMITED REMEDIES

This limited warranty defines SKF's sole and exclusive liability and Buyer's sole and exclusive remedy for any claim arising out of, or related to, any alleged deficiency in any Product sold by SKF, even if such claim is based on tort (including negligence or strict liability), breach of contract, or any other legal theory. If the Product does not conform to this limited warranty, Buyer must notify SKF or SKF's authorized service representative within thirty (30) days of discovery of the nonconformity; provided, however, that SKF shall not be liable for any claim for which notice is received by SKF more than thirty (30) days following the expiration of the applicable warranty period for the Product. Upon receipt of timely notification from Buyer, SKF may, at its sole option, modify, repair, replace the Product, or reimburse Buyer for any payment made by Buyer to SKF for the purchase price of the Product, with such reimbursement being pro-rated over the warranty period.

WARRANTY PERIOD

Except as expressly provided below, the warranty period for each Product shall commence on the date the Product is shipped by SKF to Buyer.

90-DAY WARRANTY

Products warranted for ninety (90) days by SKF are as follows: cable assemblies, MARLIN QuickConnect (MQC), magnetic temperature probes, and all refurbished equipment.

ONE-YEAR WARRANTY

Products warranted for one (1) year by SKF are as follows: all Microlog products and accessories, all Microlog Inspector applications including hand-held computers, all MARLIN data managers (MDM), all MARLIN Condition Detectors (MCD), all Wireless Machine Condition Detectors (WMCD), all Multilog On-line Systems (IMx), all Multilog Condition Monitoring Units (CMU, TMU), Multilog Local Monitoring Units (LMU), all Multilog Wireless Monitoring Units (WMx), all Wireless Monitoring Systems V/T, all Vibration PenPlus, all Machine Condition Advisers (MCA), all Machine Condition Indicators (MCI), all Wireless Machine Condition Sensors, all transmitters, all Monitor Interface Modules (MIM), all Machine Condition Transmitters (MCT), MicroVibe P and Custom Products with the prefix of CMCP (with the exception of any consumable or expendable items), Shaft Alignment Systems TKSA 60 and TKSA 80 including hand-held computer, measuring units and accessories.

TWO-YEAR WARRANTY

Products warranted for two (2) years by SKF are as follows: all standard Eddy Probes, Eddy Probe Drivers, and Eddy Probe Extension Cables, all Multilog On-line Systems (DMx), and all M800A and VM600 Machinery Monitoring Systems.

For all On-line Systems that have satisfied Criteria 1 and 2 below, the warranty period shall be either thirty (30) months from the date the On-line System is shipped by SKF to Buyer, two (2) years from the date the On-line System is installed and commissioned by SKF, or two (2) years from the date on which the installation of the On-line System has been audited and

commissioned by SKF or its authorized service representative, whichever period ends first.

Criteria 1.

Devices used with a Multilog On-line System (IMx), Multilog Condition Monitoring Unit (CMU), Multilog Local Monitoring Unit (LMU), including, but not limited to, the sensing device, the interconnect cabling, junction boxes, if any, and the communications interface, must consist only of SKF-supplied or SKF-approved devices and/or components. The computer provided by Buyer must meet the requirements stipulated by SKF.

Criteria 2.

SKF or its authorized service representative has installed the On-line System or has audited the installation and commissioned the On-line System.

“On-line Systems” are defined as systems consisting of Multilog On-line System (IMx), Multilog Condition Monitoring Unit(s) (CMU), Multilog Local Monitoring Unit(s) (LMU), and any sensing or input devices, the interconnect cabling between the sensing or input devices and the Multilog On-line System (IMx), Multilog Condition Monitoring Unit(s) (CMU), Multilog Local Monitoring Unit(s) (LMU), and the cabling between the Multilog On-line System (IMx), Multilog Condition Monitoring Unit (CMU), Multilog Local Monitoring Unit (LMU) and the proprietary SKF communications interface with the host computer.

FIVE-YEAR WARRANTY

Products warranted for five (5) years by SKF are as follows: all standard seismic sensors (accelerometers and velocity transducers).

OTHER SKF PRODUCTS

Any SKF product supplied hereunder but not covered by this limited warranty shall be either covered by the applicable SKF limited warranty then in place for such product or, if no such

warranty exists, shall be covered by the 90-day warranty stated above.

THIRD PARTY PRODUCT WARRANTIES

For any third party products sold to Buyer by SKF, SKF will transfer to Buyer any warranties made by the applicable third party product vendor to the extent such warranties are transferable.

CONDITIONS

As a condition to SKF's warranty obligations hereunder and if requested or authorized in writing by SKF, Buyer shall forward to SKF any Product claimed by Buyer as being defective. Buyer shall prepay all transportation charges to SKF's factory or authorized service center. SKF will bear the cost of shipping any replacement Products to Buyer. Buyer agrees to pay SKF's invoice for the then-current price of any replacement Product furnished to Buyer by SKF, if the Product that was replaced is later determined by SKF to conform to this limited warranty.

SKF shall not be obligated under this limited warranty or otherwise for normal wear and tear or for any Product which, following shipment and any installation by SKF (if required by the contract with the Buyer), has, in SKF's sole judgment, been subjected to accident, abuse, misapplication, improper mounting or remounting, improper lubrication, improper repair or alteration, or maintenance, neglect, excessive operating conditions or for defects caused by or attributable to the Buyer, including without limitation Buyer's failure to comply with any written instructions provided to Buyer by SKF.

SKF shall be free to conduct such tests, investigations and analysis of the Products returned to SKF, as it deems reasonable and proper in the exercise of its sole judgment. As a further condition to SKF's obligations hereunder, Buyer shall offer its reasonable cooperation to SKF in the course of SKF's review of any warranty claim, including, by way

of example only, Buyer's providing to SKF any and all information as to service, operating history, mounting, wiring, or re-lubrication of the Product which is the subject of the Buyer's warranty claim.

EXCEPT WARRANTY OF TITLE AND FOR THE WARRANTIES EXPRESSLY SET FORTH IN HEREIN, IT IS UNDERSTOOD AND AGREED THAT:

(a) SKF MAKES NO OTHER WARRANTY, REPRESENTATION OR INDEMNIFICATION, EITHER EXPRESS OR IMPLIED, INCLUDING WITHOUT LIMITATION ANY IMPLIED WARRANTY OF MERCHANTABILITY, FITNESS FOR A PARTICULAR PURPOSE, OR NON-INFRINGEMENT;

(b) IN NO EVENT SHALL SKF BE LIABLE OR OBLIGATED FOR SPECIAL, EXEMPLARY, PUNITIVE, INCIDENTAL, DIRECT, INDIRECT, GENERAL OR CONSEQUENTIAL DAMAGES (INCLUDING, BY WAY OF EXAMPLE ONLY, LOST PROFITS OR SAVINGS, LOSS OF BUSINESS OR LOSS OF USE) OR ANY OTHER LOSS, COST OR EXPENSE IN CONNECTION WITH THE PRODUCTS AND RELATED SERVICES, IF ANY, PROVIDED BY SKF, AND THIS DISCLAIMER SHALL EXTEND AS WELL TO ANY LIABILITY FOR NONPERFORMANCE CAUSED BY SKF'S GROSS OR ORDINARY NEGLIGENCE, AND IN ALL CASES REGARDLESS OF WHETHER OR NOT ANY OF THE FOREGOING WERE FORESEEABLE OR THAT SKF WAS ADVISED AS TO THE POSSIBILITY OF SUCH DAMAGES, LOSS, COST, OR EXPENSE; AND

(c) NO PERSON HAS BEEN AUTHORIZED BY SKF TO MAKE ANY FURTHER OR CONTRARY INDEMNITIES, REPRESENTATIONS OR WARRANTIES ON BEHALF OF SKF. THE FOREGOING LIMITATIONS AND DISCLAIMERS OF LIABILITY SHALL BE MADE APPLICABLE TO THE SALE OF ANY PRODUCT BY SKF TO THE FURTHEST EXTENT PERMITTED BY APPLICABLE LAW.

The exclusive remedies provided in this limited warranty shall not be deemed to have failed of their essential purpose so long as SKF is willing and able to perform to the extent and in the manner prescribed in this limited warranty.

® SKF, MARLIN, MICROLOG and MULTILOG are registered trademarks of the SKF Group.

CM-F0001 EN
Revision U, December 2012

Table of Contents

Introduction	1
Safety Messages.....	1-1
Organization of Your TKSA 60 / 80 Manual.....	1-2
Alignment System Overview	1-3
What are the TKSA 60 / 80 Alignment Systems?	1-6
Technical Specifications	1-8
The Display Unit	2
Overview	2-1
How to Use the Buttons and Keypad.....	2-2
Battery Operations.....	2-5
Wireless Communications	2-8
Display Unit Connectors.....	2-8
The Home Screen	2-9
The Measuring Units	3
Overview	3-1
Battery Information	3-2
Attaching the Measuring Units	3-2
Power Button and LED	3-9
Preparing for an Alignment Job	4
Setting Up the Display Unit and the Measuring Units	4-1
Pairing the Display Unit with the Two Measuring Units	4-6
How to Perform a Quick Alignment	5
Overview	5-1
How to Set Up a Quick Alignment (Horizontal).....	5-2
How to Perform a Quick Alignment (Horizontal) ..	5-8
How to Perform Additional Inspections.....	5-12
How to View Alignment Results (Horizontal)	5-19
How to Correct As-Found Conditions and Verify Corrections (Horizontal)	5-22
How to Set Up a Quick Alignment (Vertical).....	5-27
How to Perform a Quick Alignment (Vertical).....	5-31

How to View Alignment Results (Vertical)	5-34
How to Correct As-Found Conditions and Verify Corrections (Vertical)	5-36
How to Save the Alignment Job	5-38
The Alignment Job Report.....	5-40
Inspections	5-41

How to Set Up and Perform Full Alignment

Jobs 6

Overview	6-1
Machine Train Setup	6-2
Inspections Setup.....	6-3
Shims / Chocking Setup.....	6-4
Bolt Setup.....	6-5
Alignment Target Setup	6-6
Alignment Tolerances	6-7
Tools Setup	6-9

Working with the Job Database 7

How to Work with Previously Save Jobs	7-1
How to Create a New Machine Train	7-5
How to Create a New Machine Component.....	7-6

Safety Messages

 WARNING! *Your safety is extremely important. Read and follow all warnings in this document before handling and operating the equipment. You can be seriously injured, and equipment and data can be damaged if you do not follow the safety warnings.*

- **WARNING!** - Warning messages can alert you to an operating procedure, practice, condition, or statement that must be strictly observed to prevent equipment damage or destruction, or corruption or loss of data.
- **IMPORTANT:** Important messages means that there is a risk of product or property damage if the instruction is not heeded.

Personnel Safety

 The TKSA HA / HB Measuring Unit is a Class 2 Laser Product and emits laser radiation, do not stare into beam.

Dress properly. Do not wear loose clothing or jewelry. Keep your hair, clothing, and gloves away from moving parts.

Do not overreach. Keep proper footing and balance at all times to enable better control of the device during unexpected situations.

Use safety equipment. Always wear eye protection. Non-skid safety shoes, hard hat, or hearing protection must be used for appropriate conditions.

Do not repair or adjust energized equipment alone, under any circumstances. Someone capable of providing first aid must always be present for your safety.

To work on or near high voltage, you should be familiar with approved industrial first aid methods.

Always obtain first aid or medical attention immediately after an injury. Never neglect an injury, no matter how slight it seems.

Device Safety

Use only accessories that are recommended by the manufacturer.

Do not attempt to open the device.

Device service must be performed only by qualified SKF repair personnel.

Use only accessories recommended or provided by SKF.

Energized equipment

Never work on energized equipment unless authorized by a responsible authority. Energized electrical equipment is dangerous. Electrical shock from energized equipment can cause death. If you must perform authorized emergency work on energized equipment, be sure that you comply strictly with approved safety regulations.

Avoid Submerging in Water

This equipment has been designed to be splash and dust resistant. However, avoid direct contact with water, wet surfaces, or condensing humidity. If the instrument is subjected to these conditions, adverse operation may result, and there is a risk of serious injury or damage should electrical shock or fire occur. Allow the instrument to dry thoroughly before operation. Avoid opening the covers in locations where contact with water or other contaminants may occur.

Avoid Damage and Injury

To avoid costly damage to the instrument or injury from a falling instrument, place the instrument on a solid stable surface when not in use and do not place any heavy objects on it.

Use a damp, clean cloth for cleaning. Do not use cleaning fluids, abrasives, or aerosols. They could cause damage, fire, or electrical shock.

Avoid Battery Compartment Exposure

Do not open the battery compartment in a hazardous area, or in locations where contact with water or other contaminants may occur.

Organization of Your TKSA 60 / 80 Manual

The SKF TKSA 60 and TKSA 80 alignment tools are portable hand-held computers dedicated to performing precision machinery laser alignment. This manual introduces you to SKF's TKSA 60 / 80 alignment systems. It offers complete and detailed reference to TKSA 60 / 80 setup screens, alignment procedures and data collection displays, and data review options. This information is essential when setting up the TKSA 60 / 80 tools and when using the TKSA 60 / 80 systems to perform precision alignment jobs.

User Manual Conventions

As you use this manual, you'll discover certain conventions used:

Bold type is used to indicate text that appears in a display unit menu or data screen.

Italics are used to emphasize important information.

➤ - are used to indicate notes to the reader.

Step by step procedures are sequenced using bullets, •.

Chapter Overview

Chapter 1, Introduction – Introduces manual conventions and overviews the TKSA 60 / 80 alignment process.

Chapter 2, The Display Unit - Introduces the new user to the TKSA 60 / 80 alignment display units. This chapter provides information about display unit screens, keypads, connectors, batteries, etc.

Chapter 3, The Measuring Units – Introduces the new user to the TKSA 60 / 80 alignment measuring units. This chapter provides information about measuring unit batteries and LEDs, and how to set up the measuring units for an alignment job.

Chapter 4, Preparing for an Alignment Job – Describes how to configure display unit and measuring unit settings, and how to pair the measuring units with your display unit.

Chapter 5, How to Perform a Quick Alignment - Describes how to use the Quick Alignment feature to quickly set up and perform a precision laser shaft alignment of a motor / pump machine train only.

Chapter 6, How to Set Up and Perform Full Alignment Jobs – Describes how to set up new alignment jobs for a variety of machine trains – consisting of up to five machines, and how to pre-define an alignment job before heading off to do the alignment, including pre-selecting inspections to perform and creating a tool list to use.

Chapter 7, Working with the Job Database - Describes how to work with previously saved jobs and how to set up and store new machine trains and machine components for use with future alignment jobs.

Alignment System Overview

Shaft misalignment is one of the most significant, and most preventable, contributors to premature machine failure. When a machine is placed in service with less than optimal shaft alignment, the following conditions are likely:

- Poor machine performance
- Increased power consumption
- Increased noise and vibration
- Premature bearing wear
- Accelerated deterioration of gaskets, packing, and mechanical seals
- Higher coupling wear rates

Proper alignment is achieved when the centrelines of each shaft are co-linear when the machine is under load and at normal operating temperatures. This is often referred to as shaft-to-shaft alignment. In essence, the objective is to have a straight line through the centres of all of the shafts of the machines in the train.

The SKF Shaft Alignment Tools TKSA 60 and TKSA 80 are rugged, wireless laser shaft alignment tools that offer an easy and accurate method for adjusting two units of rotating machines so that their shafts result in a straight line.

Principle of Operation

The TKSA system uses a display unit and two measuring units. Both measuring units possess a laser and a positioning detector. As the shafts are rotated through an arc, any parallel misalignment or angular misalignment causes the two laser lines to deflect from their initial relative position.

After a straightforward measuring procedure, positioning information for the two measuring units is wirelessly communicated to the display unit, which calculates the amount of shaft misalignment and advises corrective adjustments of the machine feet.

If the shafts of a machine train are not co-linear when the machine is in operation, they are by definition misaligned. While the actual shaft positions can be illustrated in three-dimensional space and the centrelines can be defined mathematically, it is easier to relate the relationship between shafts at the coupling as an offset, an angle, or any combination of the two in the vertical and lateral axes.

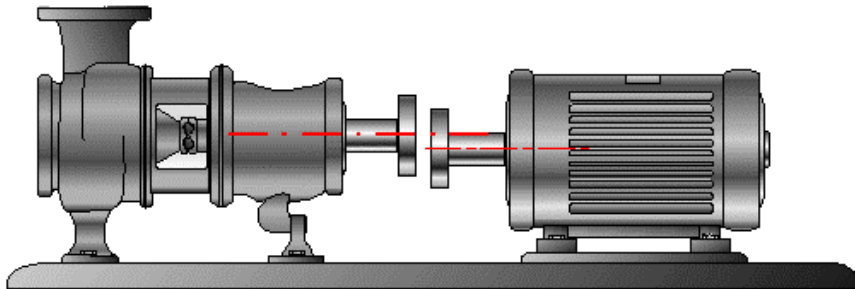

Figure 1 - 1. Offset / Parallel Misalignment.

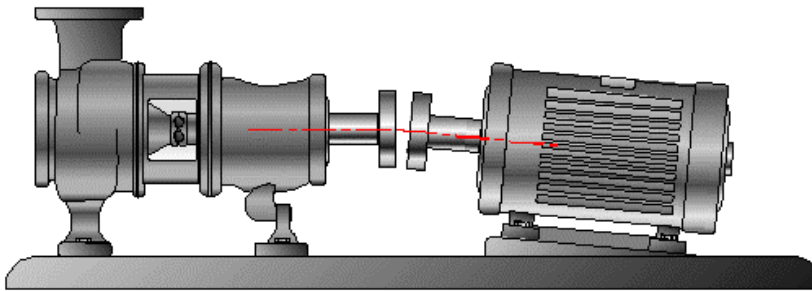

Figure 1 - 2. Angular Misalignment.

Machine Configuration

During the alignment procedure we will refer to the part of the machinery that will be adjusted as the “moveable machine.” The other part will be referred to as the “stationary machine.”

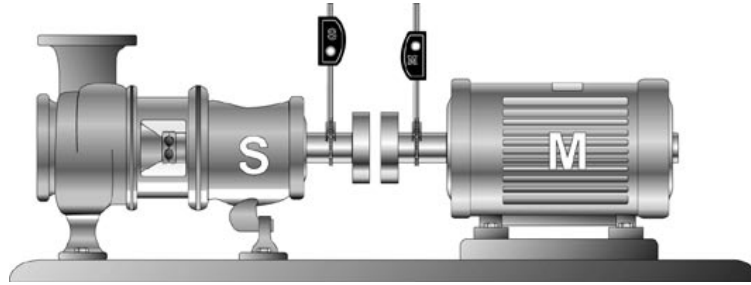

Figure 1 - 3. Stationary and Movable Machines.

Measurement Positions

To define the various measurement positions during the alignment procedure, we use the analogy of a clock as viewed from behind the movable machine. For example, measuring units located in an upright position are defined as being at 12 o'clock, while 90 degrees left or right are defined as being at 9 and 3 o'clock respectively.

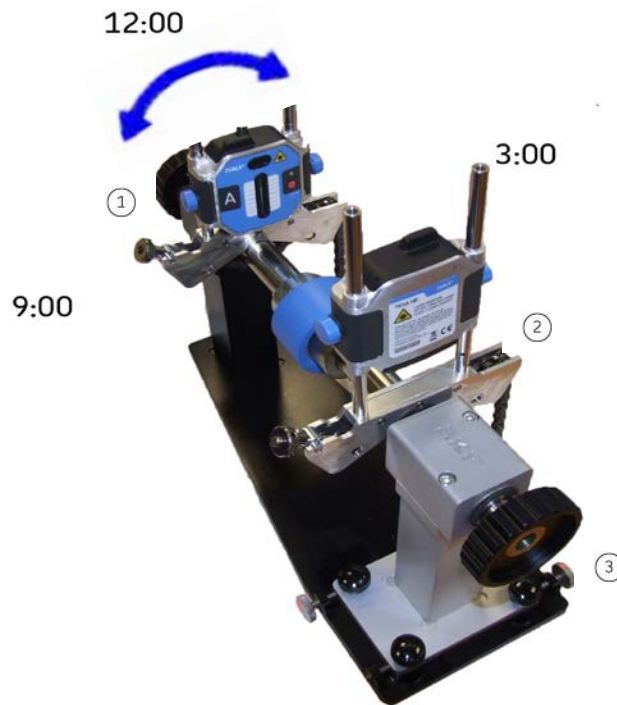

Figure 1 - 4. The Clock Analogy.

- ① measuring unit on the stationary machine
- ② measuring unit on the movable machine
- ③ movable machine

The above clock positions (9, 12, and 3 o'clock) are the most common for alignment measurements, however, measurements can be taken from any clock position. Also, while it is strongly recommended to take measurements that are 90 degrees apart,

the TKSA 60 / 80 Alignment Tools will accept a minimum rotation angle of 30 degrees from the previous measurement position.

What are the TKSA 60 / 80 Alignment Systems?

The TKSA 60 / 80 Alignment Systems are used by machinery maintenance personnel who wish to perform precision alignment of their rotating machinery, to help reduce maintenance costs and downtime.

Both the TKSA 60 and the TKSA 80 Alignment Systems consists of three major components:

- A TKSA 60 or TKSA 80 Display Unit. These display units contain the machinery alignment software application that guides users through the precision alignment process. These display units communicate wirelessly with the system's two measuring units.
- Two Measuring Units. These measuring units contain a laser, a sensor, and an inclinometer and communicate with the display unit. This allows the display unit's software to calculate the relative positions of measuring unit sensors during an alignment job.
- Measuring Unit mounting shaft fixtures, adjustable chains and rods for mounting the two measuring units to the two shafts being aligned.

Two TKSA 60 / 80 Alignment Method Options

The TKSA 60 / 80 Alignment Tools provide two methods for performing alignment inspections; Quick Alignment and Full Alignment jobs.

Quick Alignment

The Quick Alignment feature is designed to allow you to quickly perform an alignment inspection on a motor / pump machine train. It differs from doing a "full" alignment job in that, with Quick Alignments:

- You are limited to a motor / pump machine train only.
- You always perform the alignment inspection first, and then you are offered an opportunity to perform other types of inspections after the alignment inspection is complete (if additional inspections are enabled in the **Settings** screen).



- If you select to perform additional inspections, you are not forced to perform them in any specific order, although you will be warned if you attempt to do something that is not good practice.
- Some alignment setup options are pre-selected, allowing you to start the alignment job as quickly as possible.

Full Alignment Jobs

Full alignment jobs require more setup at the beginning of the alignment job and provide a more structured alignment job process.

With full alignment jobs:

- You can specify alignment inspections on machine trains other than motor / pump machine trains, including machine trains consisting of more than two machines.
- You determine which inspections will be performed at the start of the job setup by selecting from the list of available inspections for the selected machine train.
- The order in which alignment and other selected inspections are carried out is fixed, as there are specific reasons for the order imposed. The two main reasons for the enforced order are:
 - To make sure that the as-found condition for some inspections (e.g., bolt torque) is not impacted by machinery alignment movement.
 - Other causes of misalignment (e.g., shaft runout, soft foot, etc.) should be corrected before correcting the alignment.
- The user has full control over specifying the configuration of each machine in the train.

Standard Alignment Job Process

Regardless of whether you are performing a Quick Alignment or a Full Alignment job, the general TKSA 60 / 80 alignment process is as follows:

Set up the job – set up the two alignment measuring units; input machinery dimension information and alignment targets and tolerances.

Perform as-found inspections – perform initial measurements for the alignment inspection and for other selected inspections.

View results – view initial inspection results and determine whether corrections are required for each inspection.

Make corrections – if corrections are required, make corrections for each inspection requiring correction.

Perform a final as-corrected alignment inspection – After all corrections are made, re-inspect machine alignment to verify accuracy and record as-corrected job results.

Save the Job – Save the job for historical reference and for use with future alignment jobs.

Technical Specifications

Complete System

Measure distance: Up to 10 m (33.0 ft.)

Relative humidity: 10 to 90%

Temperature range: -10 to +50 °C (14 to 122 °F)

TKSA 60 Weight (with case): 7.3 kg (16.1 lb.)

TKSA 80 Weight (with case) 7.64 kg (16.84 lb.)

Display Unit

TKSA 60 Display: 4.3 inch backlit color LCD, daylight viewable

TKSA 80 Display: 7 inch backlit color LCD, daylight viewable with touch screen and keypad

Power: Rechargeable Li-ion battery and external power supply

Operating time on battery: Typical ten hours continuous operation

Storage memory: 64 MB

Housing: PC / ABS plastic with integrated lockable stand

TKSA 60 Dimensions (height x width x depth): 234 x 132 x 48 mm (9.2 x 5.2 x 1.9 in.)

TKSA 80 Dimensions (height x width x depth): 276 x 160 x 53 mm (10.9 x 6.3 x 2.1 in.)

TKSA 60 Weight: 680 g (23.9 oz.)

TKSA 80 Weight: 1,060 g (37.4 oz.)

Environment protection: IP 65

Connectivity: Low-power, industrial wireless network, 802.15.4 compliant

USB: Host v1.1, device v1.1

Drop test: 1,2 m (3.9 ft.) to MIL-STD-810F

Measuring Units (A, B)

Type of laser: Red diode laser

Laser wavelength: 635 nm

Laser safety class: Class II

Laser output power: <1 mW

Displacement measurement accuracy: $\pm 5 \text{ um} \pm 0.5\%$

Detector: Linear CCD with length 36 mm (1.4 in.)

Relative accelerometer accuracy: $\pm 0.1^\circ$ at 24°C (75°F)

- Relative accelerometer accuracy is the difference between the angles reported by the two measurement units when held at the same absolute angle.

Accelerometer resolution: 0.1°

Thermal sensors: $\pm 2^\circ\text{C}$ ($\pm 3.5^\circ\text{F}$)

Housing material: Chassis, aluminum sides, glass filled PBT

Dimensions (height x width x depth): 96 x 83 x 36 mm (3.8 x 3.3 x 1.4 in.)

Weight: 326 g (11.5 oz.)

Environment protection: IP 65

Ambient light protection: Optical filtering and ambient light signal rejection

Power supply: 2x AA alkaline batteries or rechargeable battery

Rod / fixing bar

Length: 4 of 90 mm, 4 of 150 mm, can be screwed together to increase length

Standard shaft diameter

Up to 300 mm (11.8 in.)

2 The Display Unit

Overview

The SKF TKSA 60 and TKSA 80 display units are shown below. Both display units are rugged and designed for use in harsh environments. Both units have built in wireless technology for communication with the system's measuring units. The TKSA 60 display unit provides a 4.3 inch WQVGA (480 x 272) backlit color LCD screen that is daylight viewable, and a data entry keypad interface.



Figure 2 - 1. The TKSA 60 Display Unit.

The TKSA 80 display unit has a 7 inch WVGA (800 x 480) backlit color LCD - with a daylight viewable touch screen, and also a data entry keypad interface.

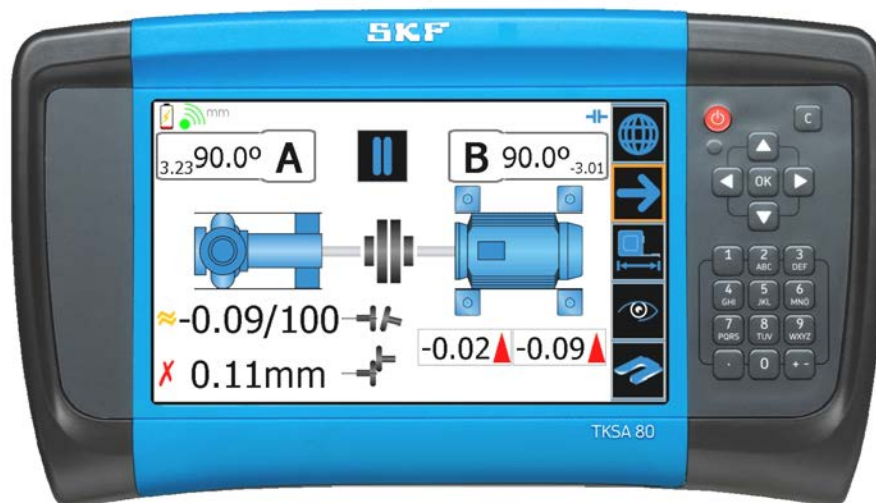

Figure 2 - 2. The TKSA 80 Display Unit.

Both display units provide 64 MB of internal memory and a rechargeable lithium ion battery that provides up to ten hours of continuous operation.

Display Unit Stand

Both display units have a built-in stand that can be used to conveniently position the device while performing alignment procedures.

To open the stand:

- Pull the stand out from the bottom of the display unit. The stand automatically locks in place when fully extended.

The stand can also be positioned to hang the display unit from a suitable hook or other projection (i.e., so it can be hung from a convenient height while performing an alignment job). To do so:

- With the stand open, facing the back of the unit, slide the stand to the right and lift toward the top of the unit. The stand automatically locks in place when fully extended.

To close the stand:

- Facing the back of the unit, slide the stand to the right and gently push it toward the bottom of the unit until it locks in place.

How to Use the Buttons and Keypad

Each display unit's user interface is identified in the diagrams below and detailed in following sections:



Figure 2 - 3. TKSA 60 User Interface.

- ① power on / off (press and hold for two seconds to turn off - enter sleep mode)
- ② battery status indicator
- ③ wireless communications status with measuring units
- ④ arrows / OK button - use to navigate display screens and select the highlighted item
- ⑤ alpha/numeric data entry keypad
- ⑥ cancel (C) button - delete last character typed
- ⑦ battery charging LED indicator

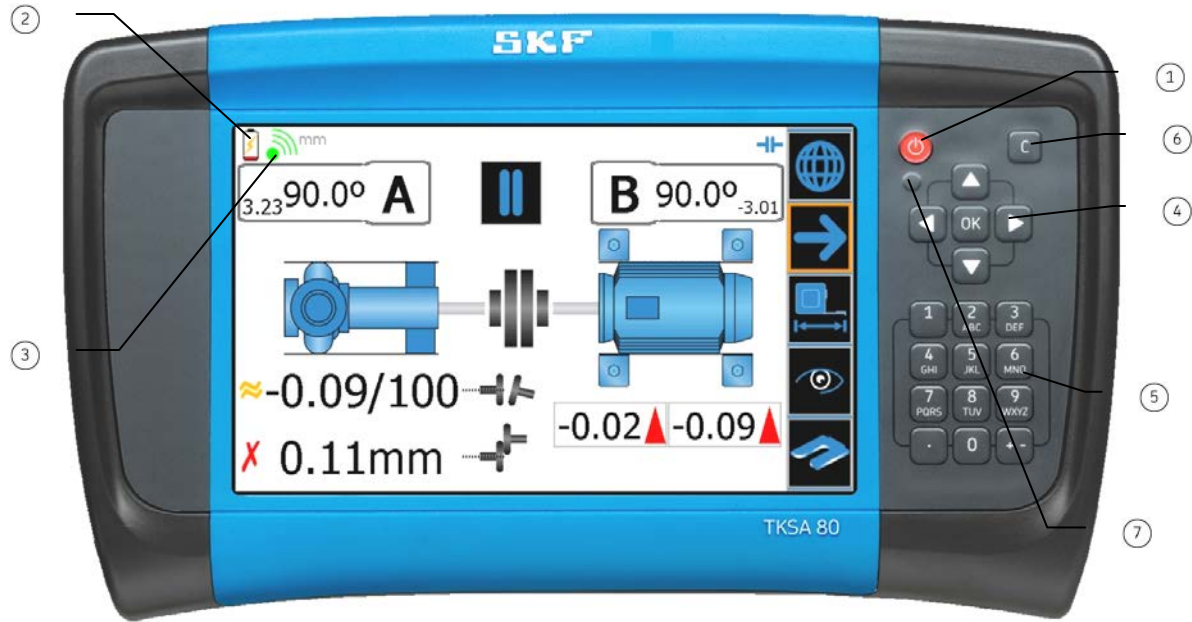

Figure 2 - 4. TKSA 80 User Interface.

- ① power on / off
- ② battery status indicator
- ③ wireless communications status (with measuring units)
- ④ arrows / OK button - use to navigate display screens and select the highlighted item (or use fingers with touch screen)
- ⑤ data entry keypad (or use on-screen alpha/numeric keypads)
- ⑥ cancel (C) button (delete last character typed)
- ⑦ battery charging LED indicator

Touch-Screen (TKSA 80 only)

Machinery alignment procedures are easily recorded on the TKSA 80 display unit's touch sensitive LCD display. The LCD display is a daylight readable color display with a pressure-sensitive resistive membrane and is activated by any blunt, non-abrasive plastic pointer (or your finger).

Power Button

The red power button powers the display unit on and off. After the initial power on, the display unit is seldom turned completely "off." Instead, the display unit is turned off and on using a "suspend / resume" process. When you press and hold the display unit's red power button for two seconds, it seems as if you are turning it "off." However, in reality you are placing the display unit in "suspend" mode. Suspend mode conserves battery power by stopping almost all activity, but leaves the display unit ready to resume operations where it left off.

- Press the red power button to turn the display unit on (i.e., initial power on), the SKF title screen initially displays, showing your unit's firmware version number. After a few seconds, the display unit automatically displays its Home screen.

- When waking up from suspend mode, the unit displays the last screen the user was using.
- Press the power button for two seconds to turn the display unit off (suspend mode).

Arrow Buttons

Use the arrow buttons to highlight the desired option or data entry field, the current option or field displays a blinking highlight, then press the **OK** button to select the highlighted option or field, the blinking highlight turns to a solid highlight to show the field is selected.

For fields that provide options in a list, after the field is selected (solid highlight), use the down arrow to cursor down the field's list until the preferred option is highlighted.

- TKSA 80 only – You may also use your finger and touch screen to select options and progress through screens.

OK Button

In any screen, press the **OK** button to select the highlighted option (blinking highlight), or to enter data in a data entry field and advance to the next field.

The Alpha/Numeric Keypad

Use the alpha/numeric keypad to input both numbers and letters in data entry fields. Note that numeric keys **2-9** also represent three or four alphabetical letters.

- To input numbers in numeric data entry fields, press the required number key.
- To input letters and/or numbers in alpha/numeric data entry fields, repeatedly press the key representing the specific number/letter as many times as necessary to display the required number/letter. This works in a similar manner to a cell phone's text entry capability. The key will first cycle through upper case letters, then the number, then lower case letters.
 - The 1 key and the 0 key both support "spaces."
 - TKSA 80 only - In addition to the unit's alpha/numeric keypad, if enabled in the unit's main **Settings** screen, the TKSA 80 display unit also provides a numeric touch screen keypad for numeric data entry fields, and an alpha/numeric touch screen keypad for alpha/numeric data entry fields.

Cancel (C) Button

When entering data in text entry fields, use the Cancel (**C**) button to delete the last character typed.

The LED Indicator

The red LED indicator located below the power button lights when connected to the AC power supply, to indicate the battery is being charged.

Battery Operations

External Power Supply

The display unit's external power supply converts AC power to DC power required by the display unit. The display unit's external power supply connector is located under a cover at the top of the display unit. You can connect the external power supply with your display unit turned on or off. The external power supply works with AC power sources worldwide. However, verify that you have a power cable designed for use in your country.

- If you are running your display unit on AC power with a battery installed, the external power supply charges the battery (if needed), then maintains the battery's charge.

⚠ WARNING! *The external power supply should be placed in a ventilated area (i.e., on a desktop) when used to power the display unit or charge the battery. Do not use the external power supply in a poorly ventilated area, as overheating may occur, possibly resulting in a fire.*

Install and Charge the Battery

IMPORTANT - Charge the battery fully before using the display unit.

Prior to using the display unit for the first time, place the lithium-ion battery in the display unit and charge the battery for at least 24 hours to ensure the battery is fully charged. The display unit's battery charges when the display unit is connected to its external power supply.



- You can operate the display unit from the external power supply while waiting for the battery to charge.



On subsequent charges, the battery charges fully in 3-5 hours. To prevent overcharging, an internal monitoring circuit shuts power off to the battery once it reaches full capacity.

Battery Life

The display units use a lithium ion battery pack that is capable of providing up to ten hours of typical use. The display units also contain a secondary backup battery that is capable of retaining the unit settings for up to two minutes while the main battery is replaced.

An icon at the upper left of the display screen displays battery status:

Icon	Status TKSA 60	Status TKSA 80
	Charging	Charging
	Fully charged – approximately 10 hours of life remain*	Fully charged – approximately 9 hours of life remain*
	Good – approximately 9 hours of life remain*	Good – approximately 8 hours of life remain*

Icon	Status TKSA 60	Status TKSA 80
	Low – approximately 80 minutes of life remain*	Low – approximately 2 hours of life remain*
	Critical – approximately 20 minutes of life remain*	Critical – approximately 50 minutes of life remain*
* Remaining battery life ratings are for typical use and will vary between units and operating scenarios.		

How to Install the Battery

⚠ IMPORTANT: To ensure proper and safe TKSA 60 / TKSA 80 operation, **ONLY use the supplied battery.**

To install the Lithium-Ion battery in your display unit:

- Loosen the screws on the battery cover located on the underside of your device and lift the battery cover away from the device.

(TKSA 60 only)

- Remove the battery by sliding the cell toward the bottom of the device and lifting it out of the device.
- Insert the replacement lithium-ion battery in the battery compartment and slide it toward the top of the device to fit into place.
- Replace the battery cover and press down firmly on the cover while re-securing the latches.

(TKSA 80 only)

- Undo the Velcro strap and gently lift the battery from the compartment.
- Disconnect the battery's cable connector.
- Connect the replacement battery's cable connector and insert the replacement battery in the battery compartment, secure with the Velcro strap.
- Replace the battery cover and press down firmly on the cover while re-securing the latches.

⚠ WARNING! To minimize the risk of serious injury or damage:
Do not expose the battery to temperatures in excess of 140°F (60°C).
Do not disassemble, incinerate, or short-circuit the battery pack.
Danger of explosion if battery is incorrectly replaced.
Replace the battery only with the same or equivalent type recommended by the manufacturer. Dispose of used batteries according to the manufacturer's instructions.
Do not open battery compartment in a hazardous / explosive area.

Replacing the Battery in an Active Display Unit

If the display unit is running from battery power only, removing the battery causes the display unit to shut off power to the LCD display. The display unit may lose any data stored in its memory.

To avoid these problems, use the following procedure to replace the battery pack in an active display unit running on battery power:

- Press the **Power** button for two seconds to suspend the display unit.
- Unlatch the battery and remove the pack.
- Replace with a fully charged battery pack and re-latch.
- Press the **Power** button.

Battery Maintenance

Dispose your SKF TKSA 60 / TKSA 80 battery according to your local regional requirements. If you are unable to dispose the battery locally, contact an SKF Certified Repair depot to request a Return Authorization (RA) number to return the battery to SKF for recycling. You may obtain an RA number from the SKF website at www.skf.com/alignment.

Use the following recommendations to prolong the life of your battery:

- If a display unit is temporarily not in use (and therefore not being regularly charged), it is important that it is recharged at least every 25 to 30 days to prevent damage to the cells.
- If the battery is left outside the display unit, it is important that it is recharged every 12 months to prevent damage to the cells.
- It is recommended to recalibrate the electronic "fuel gauge" (i.e., state of charge meter) after approximately every 30th recharge. This prevents the fuel gauge from showing an incorrect battery charge percentage. To do this, fully discharge the battery and then fully charge it without any interruptions, ideally with the unit in suspend mode (off).
- It will take longer to charge the battery if the display unit is switched on during charging. Recharge the instrument while the unit is in suspend mode (off) for the quickest recharge time.
- The battery capacity (length of the unit's operational / run time) will be reduced at temperature extremes (i.e., both high and low operating temperatures will reduce the amount of time the unit runs from the battery pack).



Wireless Communications

Overview

The display units use wireless technology to communicate with the system's two measuring units, facilitating wireless communication of measuring unit positions and movement during the alignment process.

Communications Indicator

The current communication status between the display unit and the two measuring units displays in the upper left of the screen. The communications icon displays the following information:

Icon	Status
	Wireless communications active with paired measuring units
	Wireless communications inactive (measuring units turned off or not paired)
	Error condition, failed to start wireless communications. Recover by performing a hard reset on the display unit and power cycling the measuring units.

Display Unit Connectors

Display unit connectors are located under a cover at the top of the unit. Access to these connectors is gained using the kit's provided screwdriver.



Figure 2 - 5. Connections.

- ① external power supply connector
- ② USB A connector
- ③ USB B connector

- ④ hard reset button

How to Reset your Display Unit

Should you need to reset your display unit, you have the option to perform either a hard or soft reset. A hard reset resets the display unit to its factory default values. A soft reset preserves settings previously set in the display unit.

To perform a soft reset:

- With the display unit ON, simultaneously hold down the 2, 7, 8, and 9 keys on the display unit keypad for approximately one second. The display unit application reboots and the LCD screen loads the SKF title screen, then the Home screen.

To hard reset your display unit:

- *With the display unit OFF*, unscrew the connector cover at the top of the unit.
- Using a straightened paper clip, press the reset button located between the two USB connectors. The LCD screen loads the SKF title screen, then the Home screen.











The Home Screen

When first powered on, the display unit displays its Home screen. The Home screen's title bar displays battery and system status. Home screen menu icons allow you to initiate alignment jobs, and to specify TKSA 60 / 80 system settings.



Figure 2 - 6. The Home Screen.

Home screen icons and their actions are overviewed in the following table.

Icon	Description
	Display unit's battery status
	Wireless communications status
mm	Length units of measurement
	Initiate a Quick Alignment (motor / pump machine train only)
	Initiate a Quick Soft Foot job (motor / pump machine train only)
	Set up and perform a full alignment job
	Open an existing alignment job stored in the job database; add new machine trains to the database (TKSA 80 only); add new machine components to the database (TKSA 80 only)
	Export reports to a USB memory stick for transfer to PC
	Modify the display unit's Settings, and set up the two laser measuring units
	Display context sensitive Help
	Display system information (including application version number and unit ID number)

Help



Context sensitive help can be accessed from either the Home screen, as shown in the previous section, or from the Global Functions menu, as discussed later in this chapter's **Global Functions** section. When accessed, the **Help** screen displays information about the currently displayed screen and options available.

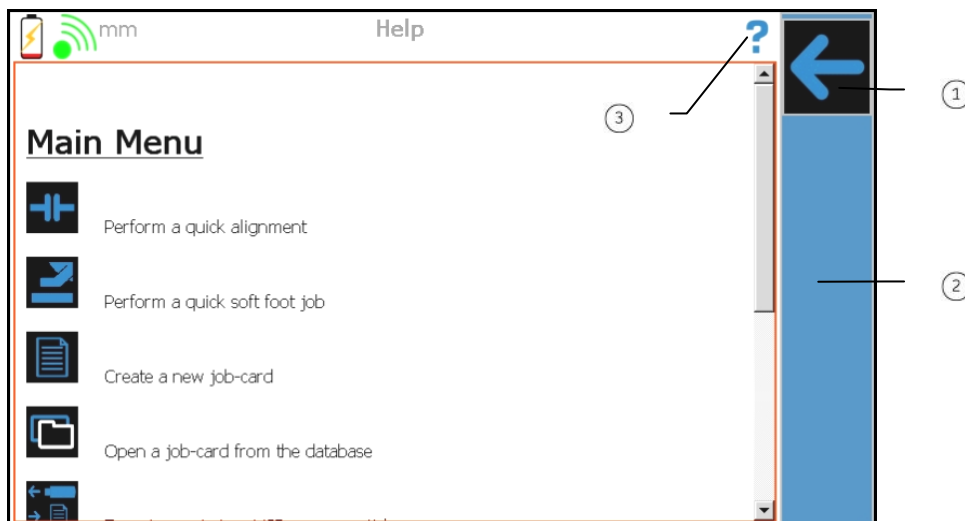

Figure 2 - 7. The Home Screen's **Help** Screen.

- ① back to previous screen
- ② depending on the active screen, the context sensitive “right panel menu” allows you to go back to the previous screen or advance to the next screen (left / right arrow icons), display Global Functions, or select additional display screens.
- ③ current operating mode indicator

System Information – the About Screen



The **About** screen is accessed from the Home screen, as described in the previous section. The **About** screen displays information about your system’s display unit, its firmware version, its wireless firmware, and any licensed features.

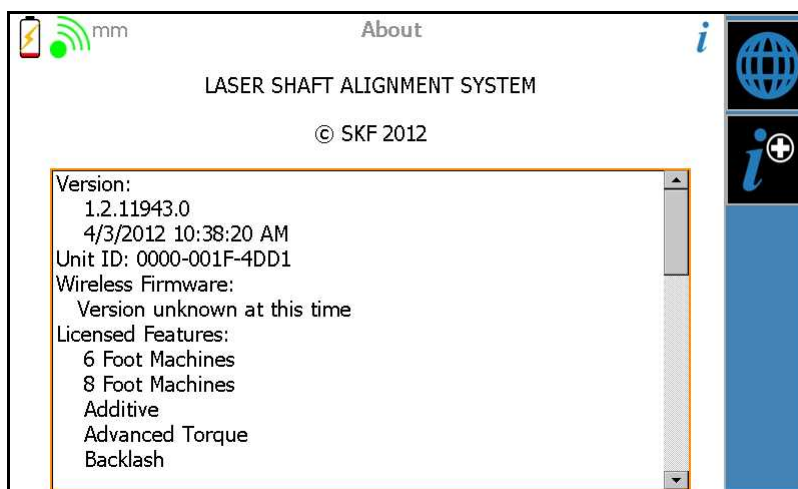

Figure 2 - 8. The **About** Screen.

The display unit’s **Unit ID** is required when purchasing new licenses for the display unit. Current **Licensed Features** are displayed in the **About** screen, along with the date of expiration for each licensed feature. If no date is displayed, then the license is permanent.

Icon	Description
	Global functions menu – available from most screens, displays context sensitive global functions (reference the following Global Functions section)
	More system information (see below)



Select the “more system information” icon to display additional information about your display unit. Detailed information is displayed for individual software element versions installed on the unit. If you encounter a problem that requires assistance from SKF Technical Support, you may be asked to provide information from the “more system information” screen.







The Global Functions Menu



Figure 2 - 9. An Example Global Functions Menu.



At the top of the right panel menu, select the **Global Functions** icon to display context sensitive global functions (i.e., depending on the active screen, one or more of the global functions icons above display). Global functions are overviewed in the following table.

Icon / Menu	Description
	Displays the context sensitive Global Functions menu (described below in this table).
	Go back to the previous screen.
	Display the Home screen.
	Display the main Settings screen.
	Add free text note for current inspection/job which will be included as part of the final job report.
	Display context sensitive Help.

The Measuring Units

Overview

The SKF Alignment kit contains two measuring units, labeled **A** and **B**. These measuring units contain a laser and a sensor that allow the display unit's alignment application to calculate the relative positions of the sensors during an alignment job.

The measuring units should be attached to the shafts at either side of the coupling being aligned. If it is not possible to attach the measuring unit fixtures directly to the shafts (i.e., not enough space), the fixtures may be attached to the coupling.



Figure 3 - 1. The TKSA HA and TKSA HB Measuring Units (Front).



Figure 3 - 2. The TKSA HA and TKSA HB Measuring Units (Rear).

With the SKF TKSA 60 / 80 alignment application, the measuring units are referred to individually as measuring unit **A** and measuring unit **B**. The user can attach either of the measuring units to either side of the machine train (stationary or moveable sides). Then, using the alignment application, the user specifies which measuring unit is attached to the moveable machine shaft, and which is attached to the stationary machine shaft.

Battery Information



Figure 3 - 3. Battery Location.

The measuring units are each fitted with two batteries. When the batteries require replacement, they can be replaced with any alkaline or rechargeable AA size batteries. The measuring units are designed to be used with NiMH batteries and, when used with this type, have a battery life of up to eight hours of typical use.

- It is advisable to bring four extra AA replacement batteries with you to the alignment job, in case the measuring units' batteries lose their charge.

To conserve battery life, measuring units are programmed to turn off if there is no communication from the display unit for five minutes (e.g., if the display unit is turned off).

If the measuring unit's battery status reaches critical, the LED indicator on the front of the unit flashes a short on and long off about once / second. Reference the **Power Button and LED** section later in this chapter for more information on the measuring unit's LED indicator.

Attaching the Measuring Units

Attaching the measuring units to the shafts (or coupling) being aligned is a two-step process. The first step is to attach the v-brackets to the shafts using the chain assemblies. After the v-brackets are secured to the shafts, the next step is to attach the measuring units to the v-brackets' measurement rods.

Two v-brackets are provided. Both must be mounted on the shaft in accordance with the following instructions.



Figure 3 - 4. The Two V-Brackets.

To attach the v-bracket to the shaft:

- First, screw the longer set of measurement rods into the v-bracket (as shown) and tighten.



Figure 3 - 5. Screwing the Long Rod into the V-Bracket.

Four short rods and four long rods are provided and can be connected to provide a longer rod if required.

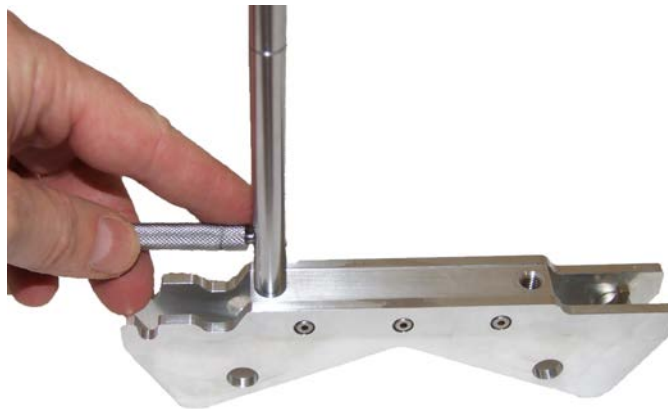

Figure 3 - 6. Tightening with the Tommy Bar.

The supplied tommy bar can be used to tighten the rods, if required.



Figure 3 - 7. Chain, Pivot, and Knurled Knob.

The standard chain supports shafts up to 125 mm (4.9 in.), the standard plus extension chain supports shafts up to 300 mm (11.8 in.). The chain assembly is comprised of – the chain (fitted with a threaded pull bar), a pivot, and a knurled knob.



Figure 3 - 8. The Chain Assembly.

- To assemble the chain assembly, place the pivot over the threaded pull bar. Then screw the knurled knob onto the pull bar to keep the pivot captive.



Figure 3 - 9. Attaching the Chain Assembly to the Anchor.

- The first step in attaching the v-bracket to the shaft is to hook the chain onto the anchor in the v-bracket. At this stage, it is not important which link is used to hold the chain.



Figure 3 - 10. Attaching the Pivot to the V-Bracket.

- Next, place the v-bracket on the shaft and loop the chain beneath the shaft. Then, drop the pivot into the slots on the top surface of the v-bracket to hold this end of the chain in place.



Figure 3 - 11. Tightening the Chain on the Anchor.

- Now, on the opposite end of the chain, remove the chain from the anchor and pull it as tight as possible, and then re-anchor it using the most appropriate link. For small shafts, it may be preferable to route the chain between the centre block and the anchor.

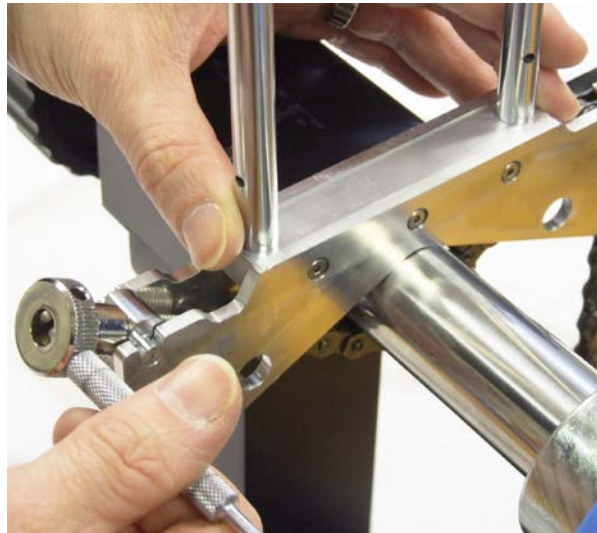

Figure 3 - 12. Securing the V-Bracket to the Shaft.

- Finally, using the knurled knob (and tommy bar if required), tighten the chain to allow it to grip the shaft and hold the bracket assembly tight.
- Repeat this procedure for the other v-bracket, make sure the v-bracket arrows point towards the coupling.

Now that the v-brackets are secured on the shaft, your next step is to mount the measuring units onto the v-brackets' rods.

Each measuring unit contains a laser and a CCD sensor (vertical strip surrounded by white grid).

- When setting up the system, both lasers will be turned on brightly so that the ideal starting position can be attained.

To fit the measuring units to the secured v-brackets:

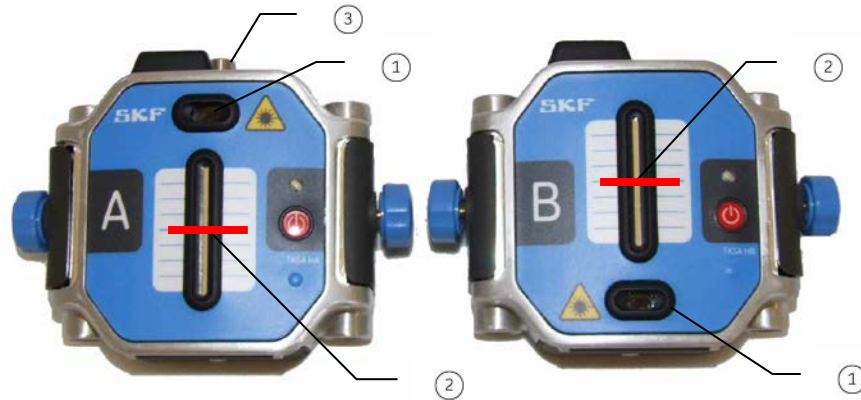

Figure 3 - 13. Laser, Sensor, and Pitch Knob Locations.

- ① lasers
- ② CCD sensors and sensor grids
- ③ pitch adjustment knob

- Fit the measuring units onto the v-brackets' measurement rods – to do so, loosen the rod clamps of the sides of the measuring units and slide the measuring units onto the measurement rods so that the front of the A and B measuring units face each other.
 - It does not matter which measuring unit you mount on which shaft, the TKSA 60 / 80 application allows you to specify your setup.
- Position the A measuring unit as low as possible on the rods without it being blocked by the coupling.
- Position the B measuring unit approximately 18 mm (0.71 in.) higher than the A measuring unit - so that the B unit's laser line hits the centre of the A unit's white sensor grid (red line in above figure).
- Use the A unit's adjustment knob to alter the pitch (up or down as necessary) of the A unit's laser so that it hits the centre of the B unit's white sensor grid.
 - It is important that the laser line hits as closely as possible to the centre of the CCD sensor grid, as shown above.
- Tighten the rod clamps on the sides of the measuring units to secure the measuring units to the measurement rods.



Figure 3 - 14. Measuring Unit Mounted on V-Bracket.

- During the alignment measurement process, the lasers will dim and alternate between the two measuring units.

Laser Pitch Adjustment

As previously mentioned, measuring unit A (TKSA HA) has an adjustment knob on the top of the unit that allows for a fine adjustment of its laser's pitch angle. Such an adjustment may be required in order to line the laser up with the target sensor on measuring unit B (TKSA HB). This adjustment knob uses a stiff-turn mechanism, which allows for an accurate laser adjustment without the need for a locking mechanism (which could otherwise cause problems with shifting the alignment position).

This adjustment knob has a broad green band indicating the measuring unit's designed operating range. The adjustment knob should not be screwed in so far that the green "operating range" band is not visible, nor should it be unscrewed so far that the metal below the "operating range" band can be seen. Faulty measurements may result when operating the measuring unit outside its designed operating range.

Power Button and LED

Use the measuring unit's power button and green LED to operate the measuring unit and to place the measuring unit in various operating modes. The LED also indicates battery life status.

The chart below overviews the use of the measuring unit's power button and LED.

Power Button Action	Green LED Indicator	Measuring Unit Status
None	Off	Unit is off
Normal press and release (power on)	Quick flash (4 / second)	Unit is starting up
None (after initial power on)	Constant on	Unit is on
Press and hold for two seconds	Slow flash (1 / second)	Unit is in pairing mode, to be registered with the display unit
Normal press and release (power off)	Off	Unit is off
TKSA HA / HB Battery Status		
Status	Alkaline batteries	Rechargeable batteries
Low	Battery "low" display on Display Unit (45 minutes of life remaining)*	Battery "low" display on Display Unit (1 hour of life remaining)*
Critical	Battery "critical" display on Display Unit – also one short flash / second on measuring unit LED - 15 minutes of life remaining*	Battery "critical" display on Display Unit – also one short flash / second on measuring unit LED - 30 minutes of life remaining*
* Remaining battery life ratings are for typical use and will vary between units and operating scenarios.		

Information on pairing measuring units with your display unit and using the measuring units during an alignment job is found in the next **Chapter 4, Preparing for an Alignment Job**.

Preparing for an Alignment Job

Setting Up the Display Unit and the Measuring Units



From either the Home screen or the right panel menu, select the **Settings** icon to display the main **Settings** screen.

Display Unit Settings

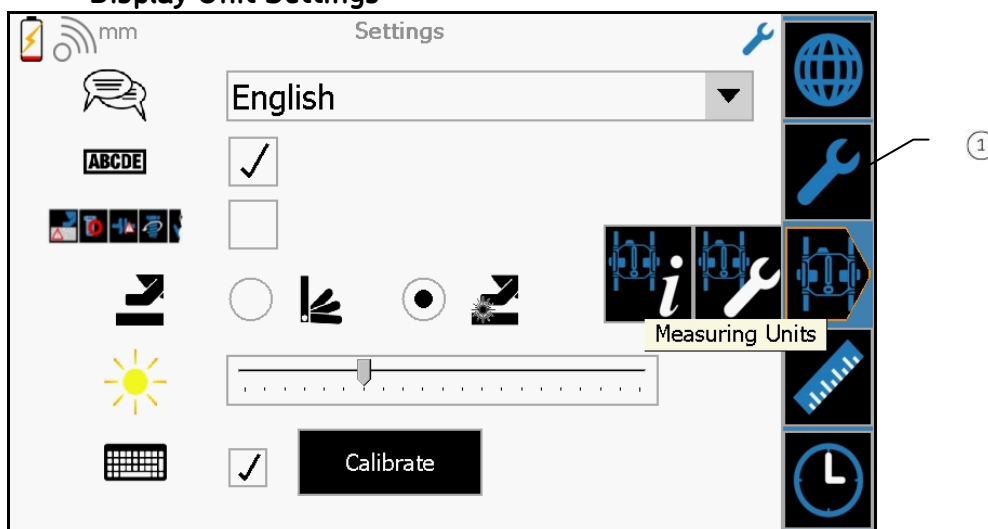









Figure 4 - 1. The Main **Settings** Screen.

① context sensitive “right panel menu” showing other settings options.

Settings screen icons and menu options are overviewed in the following table.

Icon	Description
	Language selection - select the display unit's language from the drop-down menu.
	Display icon prompts - when enabled, a short description displays beneath the currently selected screen icon.
	Enables/disables the additional inspection menu shown during a quick alignment job.
	Specify soft foot measurement type – select either feeler gauges (manual) or laser measuring units .
	Screen brightness - adjust the slider to specify the screen brightness. Note - higher brightness levels reduce battery life.
	(TKSA 80 only) Enable to display a touch screen keyboard when a data entry field is selected.
	(TKSA 80 only) Select the Calibrate button to re-calibrate the touch screen – follow on-screen prompts.

Right Panel Menu	
Right panel menu items are available from all setup screens and are detailed in following sections.	
	Global Functions – reference the previous Global Functions section.
	Main Settings screen – when other Settings screens are selected (see below) allows you to return to the main Settings screen.
	Measuring Units Settings – used to select Measuring Units information/pairing or settings
	Measuring Units Information/Pairing
	Measuring Units Settings
	Units of Measurement Settings
	Date and Time Settings

- After changing your settings, use the right panel menu to change other settings or use the Global Functions menu to exit the Settings screen and return to the Home screen.

Measuring Units Information/Pairing



From any Settings screen, select the Measuring Units Setting icon and then select the Measuring Units Information/Pairing icon to display the Measuring Units **Settings – Information** screen.

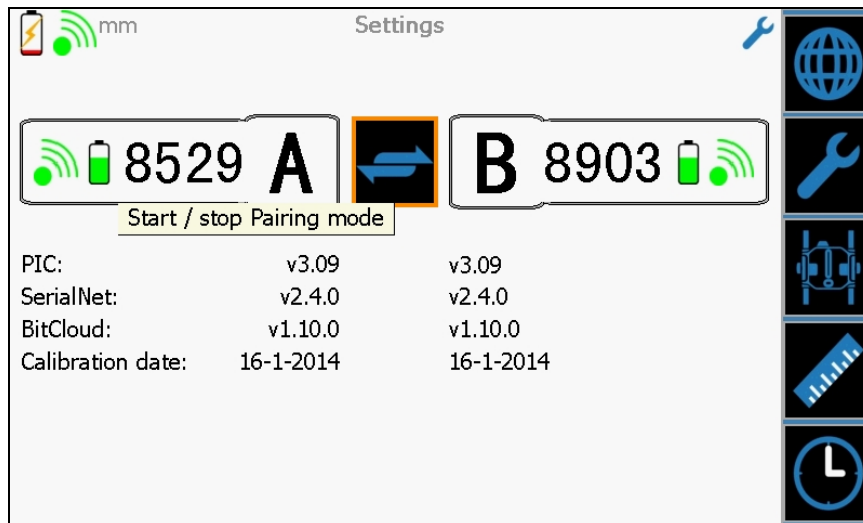



Figure 4 - 2. The Measuring Units **Settings – Information** Screen.

This screen's icons and menus allow you to configure your system's two laser measuring units. Measuring Unit settings icons and menus are overviewed in the following table.

Icon / Menu	Description												
	Displays the IDs (last four digits of MAC address) of the currently paired A and B measuring units and their wireless status with the display unit. If these measuring units are powered on and in range, their battery status is also displayed.												
<table border="1"> <tr> <td>PIC:</td> <td>v3.08</td> <td>v3.08</td> </tr> <tr> <td>SerialNet:</td> <td>v2.4.0</td> <td>v2.4.0</td> </tr> <tr> <td>BitCloud:</td> <td>v1.10.0</td> <td>v1.10.0</td> </tr> <tr> <td>Calibration</td> <td>7/3/2013</td> <td>7/3/2013</td> </tr> </table>	PIC:	v3.08	v3.08	SerialNet:	v2.4.0	v2.4.0	BitCloud:	v1.10.0	v1.10.0	Calibration	7/3/2013	7/3/2013	<p>PIC - measurement unit firmware version</p> <p>SerialNet and BitCloud - wireless firmware layers, each has its own firmware version</p> <p>Calibration date - date each measuring unit was calibrated.</p>
PIC:	v3.08	v3.08											
SerialNet:	v2.4.0	v2.4.0											
BitCloud:	v1.10.0	v1.10.0											
Calibration	7/3/2013	7/3/2013											
	Enter / Exit Pairing Mode. Pairing Mode is detailed later in this chapter.												

- If the calibration date is indicated in red, calibration data is incomplete and you will not be able to perform any measurements. If you attempt to perform a measurement, a message displays, warning you that the calibration data is invalid. In this case, the measuring units should be recalibrated before proceeding. If the calibration date is indicated in blue, the unit is due for recalibration. If black, then the calibration data is current and valid.

Measuring Units Settings



From any **Settings** screen, select the Measuring Units Settings icon and then select the Measuring Units Setting icon to display the Measuring Units **Settings** screen.

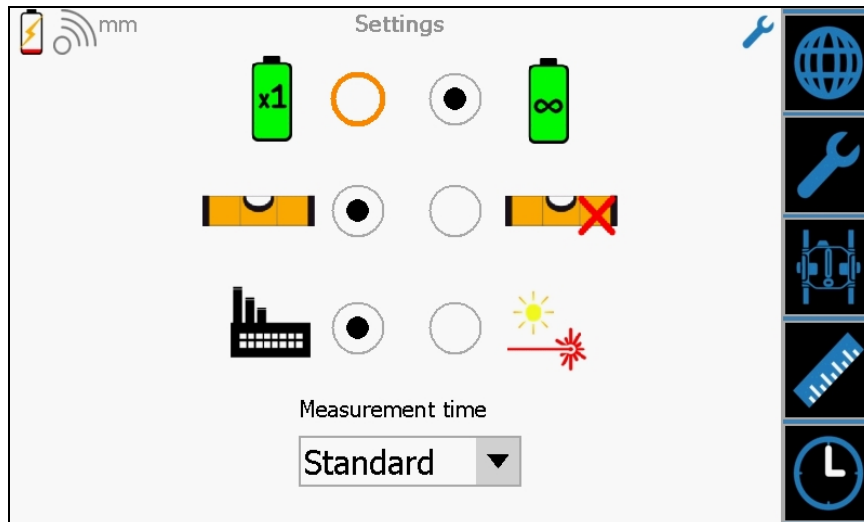
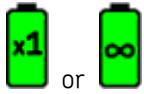







Figure 4 - 3. The Measuring Units **Settings** Screen.

This screen's icons and menus allow you to configure your system's two laser measuring units. Measuring Unit settings icons and menus are overviewed in the following table.

Icon / Menu	Description
	<p>Specify whether the currently paired measuring units are using disposable batteries or rechargeable batteries. Required for accurate battery status information.</p>
	<p>Specify whether the inclinometers should be used to determine the current angle of the measuring units. If switched off  then the display unit will prompt the user to perform measurements/corrections at fixed clock positions (9-12-3). This setting is useful when it is difficult to obtain stable angle readings, e.g. on a boat.</p>
	<p>Specify the lighting conditions of where you are using the system. Select the indoors icon  (default setting) when using the system indoors or under normal lighting conditions. Select the outdoors icon  when using the system outdoors. The outdoor mode will increase the time to take measurements, but improves stability in variable light conditions.</p>
<p>Measurement Time</p>	<p>Specify the measurement time for the paired measuring units. Options are Fast / Standard / Slow. Slow readings help reduce the impact of noise that may be introduced in an environment with a high level of background vibration.</p>

- After changing your settings, use the right panel menu to change other settings or use the Global Functions menu to exit the **Settings** screen and return to the Home screen.

“Units of Measurement” Settings



From any **Settings** screen, select the “Units of Measurement” settings icon to display the Units of Measurement screen.

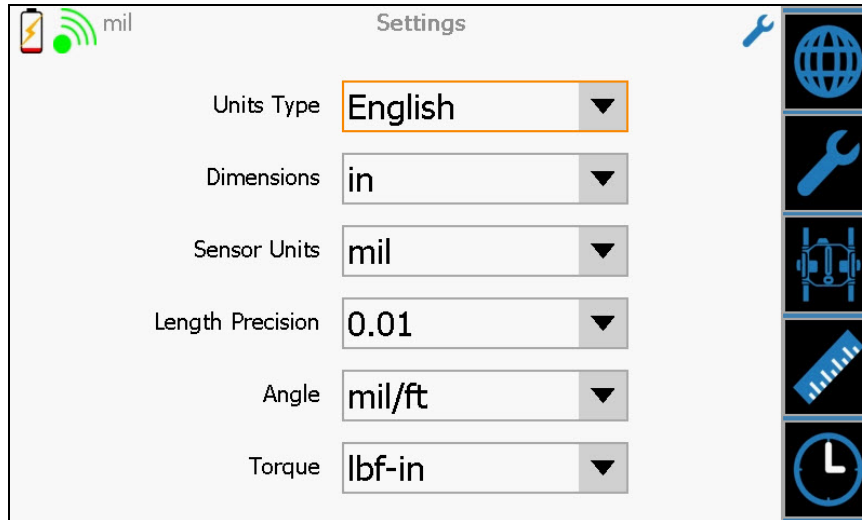

Figure 4 - 4. The Units of Measurement **Settings** Screen.

This screen’s menus allow you to configure your system’s units of measurement. Units of measurement menus are overviewed in the following table.

Icon / Menu	Description
Units Type	Specify either English or Metric measurement units.
Dimensions	Specify the units to display for the machine dimensions (e.g., Metric - mm, cm, or m ; English - mil, in, or ft). <ul style="list-style-type: none"> ➤ Since machines are usually large, their dimensions are often specified with larger units of measure (e.g., cm / m or in / ft), whereas sensor readings and misalignment values usually require smaller units of measure (e.g., mm / cm or mil / in).
Sensor Units	Specify the units to display for misalignment values / sensor readings (e.g., Metric - mm, cm, or m ; English - mil, in, or ft).
Length Precision	Specify the number of decimal places to use, either 0.1, 0.01, or 0.001 .
Angle	Specify how to display angular misalignment; for Metric units - /100 (mm / 100 mm); for English units mil/in, mil/ft, in/in, or in/ft .
Torque	For Metric units, specify to measure torque in either Nm or KNm ; for English units, specify either lbf-in or lbf-ft .

After changing your settings, use the right panel menu to change other settings or use the Global Functions menu to exit the Settings screen and return to the Home screen.

Date and Time Settings



From any **Settings** screen, select the “Date and Time” settings icon to display the Date and Time **Settings** screen.

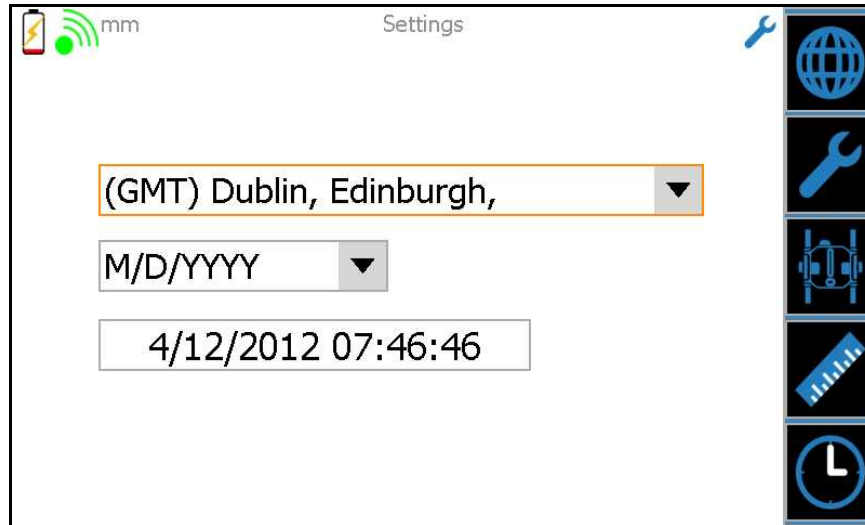

Figure 4 - 5. The Date and Time **Settings** Screen.

This Settings screen allows you to configure your display unit’s date and time settings. Date and time menus are overviewed in the following table.

Icon / Menu	Description
Time zone	Specify your time zone from the pull down menu.
Date Format	Specify the date format.
Date / Time	Enter the current date and time.

After changing your settings, use the right panel menu to change other settings or use the Global Functions menu to exit the **Settings** screen and return to the Home screen.

Pairing the Display Unit with the Two Measuring Units

Overview

The pairing procedure enables wireless communications between the display unit and two specific measuring units. The TKSA 60 / 80 Systems are shipped to you with your measuring units already paired to your display unit. However, if at some future time you change or replace one or both of your measuring units, you must use the pairing process to enable communications with the new measuring unit(s).

Measuring units are identified by their MAC addresses, which are located on the back of each measuring unit.

How to Pair the Display Unit with Your Measuring Units

To initiate the pairing process:

- As described earlier, power on your A and B measuring units and put them in pairing mode (press and hold the red power button for two seconds). Make sure the measuring units are within a three meter (ten foot) radius of the display unit.



- On the display unit, from any settings screen, select the right panel menu's Measuring Units Settings icon and then select the Measuring Units Information/Pairing icon to display the Measuring Units **Settings** screen.

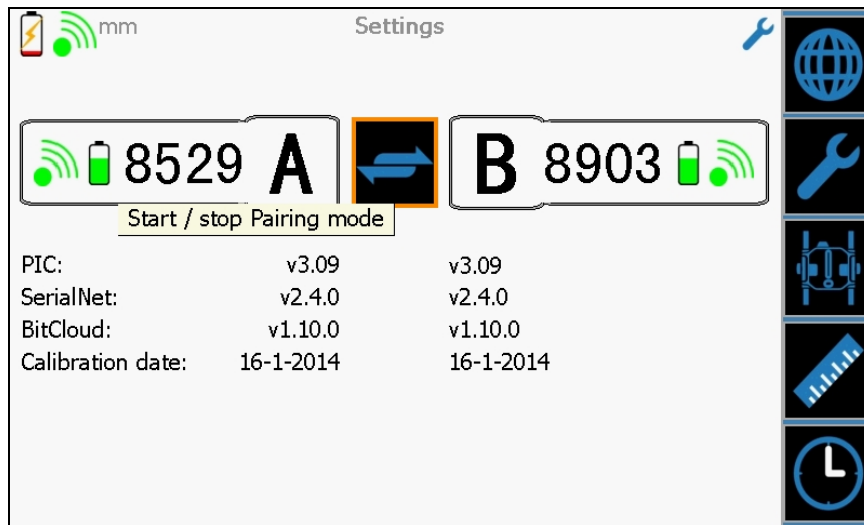

Figure 4 - 6. The Measuring Unit **Settings** Screen.



- From the Measuring Units **Settings** screen, select the "Enter / Exit Pairing Mode" icon to enter pairing mode. The pairing mode screen displays.

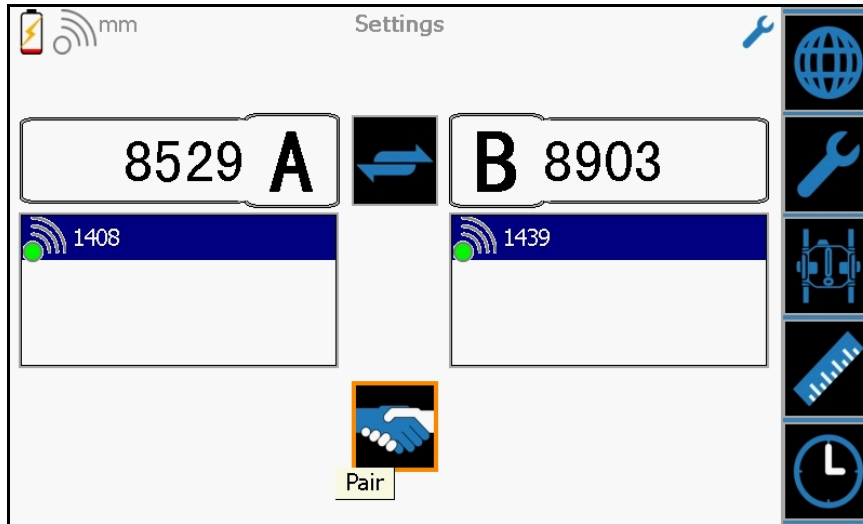





Figure 4 - 7. The Pairing Mode Screen.





The pairing mode screen displays two lists, one on the left, the **A** list - and one on the right, the **B** list. These lists show their respective measuring units (A and B) that are in range and in pairing mode. IDs of the A and B measuring units that are currently paired with the display unit appear at the top of the lists.

- If measuring units are placed in pairing mode after the pairing mode screen is displayed, the pairing mode screen automatically updates to show the new measuring units. This update may take several seconds.

Additional information on the pairing mode screen is overviewed in the following table.



Icon / Menu	Description
 7157 A B 1412 	IDs of A and B measuring units that are currently paired with the display unit (last four digits of the MAC address on the back of the measuring unit). Note – wireless status icons are disabled while in pairing mode.
Left "A" list	IDs of all A measuring units within range and in pairing mode.
Right "B" list	IDs of all B measuring units within range and in pairing mode.
	Pair with measuring units - select to pair with the currently selected measuring units in each list.
	Enters / Exits pairing mode.

The status of each “available” measuring unit displayed in the lists is indicated by one of the icons below:

Icon	Status
	Measuring unit is currently paired with this display unit.
	Measuring unit currently paired with another display unit (stolen).
	Measuring unit has been previously paired with display unit. Display unit is currently paired with another measuring unit. OK to pair with this measuring unit.
	Measuring unit is unpaired.

All measuring units displayed in the two lists can be paired with your display unit, however, consideration should be given to whether the measuring unit’s icon is indicating that it is currently paired with another display unit.

To pair with specific measuring units:

- Select an A measuring unit from the A list and a B measuring unit for the B list.
-  Select the “pair” icon to pair with the two selected measuring units. The display unit waits for the selected measuring units to pair with the display unit and then for the measuring units to reboot and initiate communications with the display unit (this may take some time). After this has taken place, the display unit exits pairing mode and returns to the Measuring Units **Settings** screen, where the IDs and information for the newly paired measuring units display.
-  Exit pairing mode without attempting to pair with any measuring units and return to the Measuring Unit **Setup** screen.

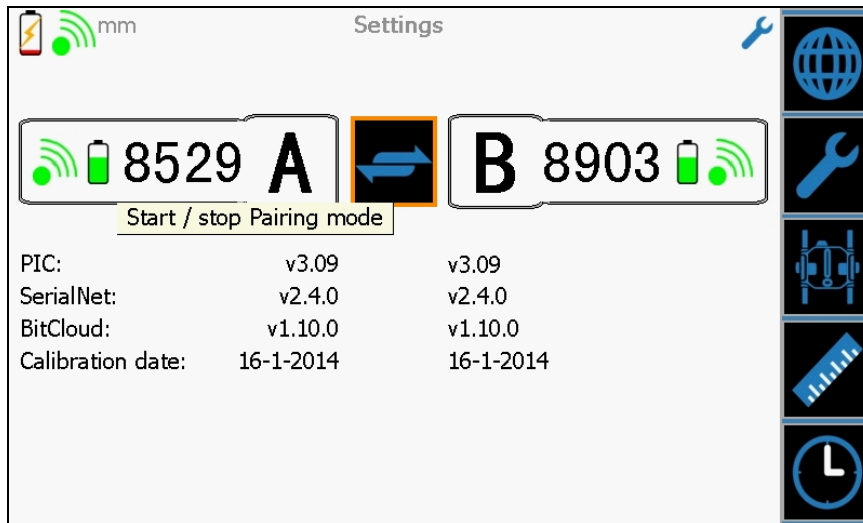





Figure 4 - 8. A Successful Pairing.

Paired Status

With a successful pairing, the measuring unit setup screen displays as shown.

 The wireless communication icon at the top left of the screen displays green only if both measuring units are successfully paired and currently active.

The wireless icon displayed with each measuring unit's ID and battery status displays the status of the individual measuring unit according to the following table.

Icon	Status
	The measuring unit is paired and active
	The measuring unit is not paired, or is in-active.
	Error condition, contact SKF Technical Support

How to Perform a Quick Alignment

Overview

The Quick Alignment feature is designed to allow you to quickly perform an alignment inspection on a motor / pump machine train. It differs from doing a “full” alignment job in that, with Quick Alignments:

- You are limited to a motor / pump machine train only.
- You always perform the alignment inspection first, and then you are offered an opportunity to perform other types of inspections after the alignment inspection is complete (if additional inspections are enabled in the **Settings** screen).



- If you select to perform additional inspections, you are not forced to perform them in any specific order, although you will be warned if you attempt to do something that is not good practice.
- Some alignment setup options are pre-selected, allowing you to start the alignment job as quickly as possible.
 - To learn more about performing full alignment jobs, reference **Chapter 6, How to Set Up and Perform Full Alignment Jobs.**

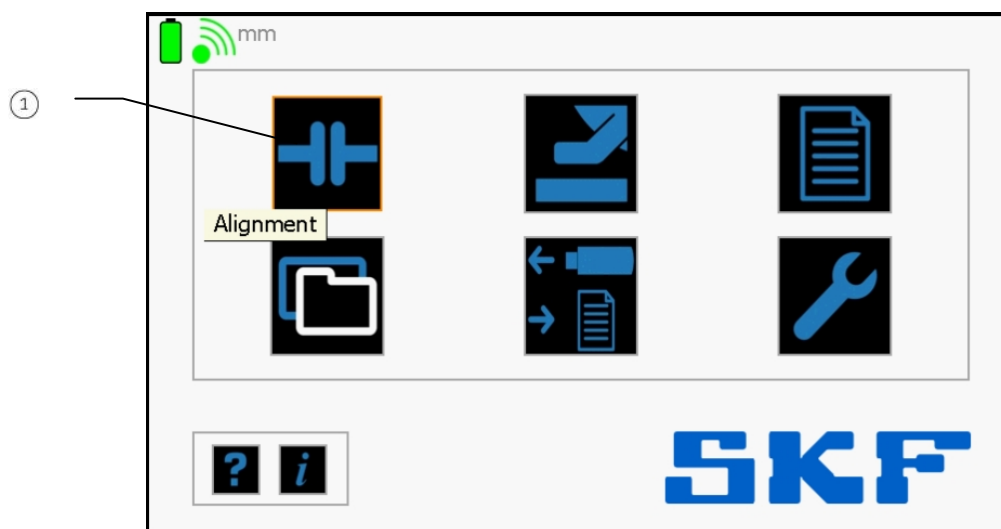



Figure 5 - 1. Selecting Quick Alignment.

① quick alignment icon

Steps in an Quick Alignment Job

The sequence of steps for a typical Quick Alignment job is:

- Specify the machine dimensions.
- Specify the alignment tolerances (targets default to 0, 0).
- Record three initial alignment measurements to calculate the as-found machinery alignment.
- (If additional inspections are enabled in the **Settings** screen, select and perform additional inspections as required).

- View the as-found alignment results and determine if corrections are required.
- (If additional inspections were performed, view results for the additional inspections and determine if corrections are required.)
- If alignment corrections are required, make alignment corrections to both vertical and horizontal planes.
- (If corrections are required for any additional inspections performed, make corrections and re-record the inspection.)
- Re-inspect the alignment to record the as-corrected alignment.

How to Set Up a Quick Alignment (Horizontal)

To set up a horizontal Quick Alignment:

- From the Home screen, select the Quick Alignment icon. The **Quick Alignment Menu** screen prompts you for the orientation of machine train on which you are performing the alignment, **Horizontal** or **Vertical**.

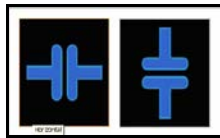

Figure 5 - 2. Horizontal or Vertical Alignment Icons.

- Specify to perform a horizontal alignment. The machine **Dimensions** screen displays.
 - Vertical alignments are discussed later in this chapter.

Specifying Machine Dimensions

Ideally, it is best to position the measuring units and line up the lasers before you enter the machine dimensions. You should align the measurement units as best as possible, which might require you to fine adjust the brackets. This should be done before measuring anything, to provide the most accurate results possible.

Also, make sure the laser beam is hitting the sensor near enough away from the edges so that it won't drop off the top / bottom of the sensor as the user rotates the shaft.

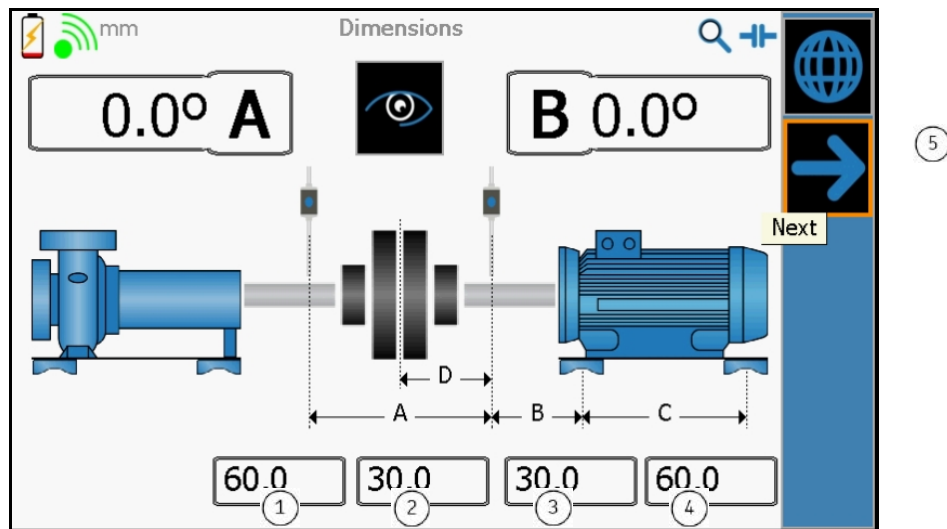

Figure 5 - 3. The Horizontal Alignment Machine **Dimensions** Screen.









Use the machine **Dimensions** screen to specify machine dimensions for the machines you are aligning. The specified dimensions are used in the alignment application's calculations. Note that the **Dimensions** screen displays:

- When setting up for a misalignment measurement.
- If you switch the movable and stationary machines during an alignment job.
 - If dimensions have already been entered for the Quick Alignment, they will be automatically recalled, allowing you to verify that they are correct and then select the **Next** button to continue.

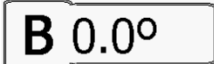
The **Dimensions** screen shows two machines and their coupling. These two machines may describe the whole machine train or, if there are three or more machines in the machine train, part of a machine train - depending on the current alignment job. The two measuring units (A and B) are also shown.

- Quick Alignment jobs are limited to two machines, a motor and a pump.

Dimensions screen items for horizontal machine alignments are overviewed in the following table and discussed in detail later in this section.

Icon / Menu	Description
	View options – update the displayed machine image so that it matches the actual machinery setup being aligned. Reference the following View Options section for details.
	Measuring Unit A position status. Displays the measuring unit's position on the shaft and the centroid reading on the sensor. If the measuring units drift too far apart, the measurement units misaligned icon will appear. If laser is not hitting the sensor, then the centroid reading is not shown. For vertical alignment or alignment with the inclinometers switched off () , the angle readings will not appear. <i>Note - For the dimensions page, the centroid reading is not displayed as the lasers are switched on at full brightness which can lead to fluctuating readings at short distances.</i>
	Measuring Unit B position status. Displays the measuring unit's position on the shaft and the centroid reading on the sensor. If the measuring units drift too far apart, the measurement units misaligned icon will appear. If laser is not hitting the sensor, then the centroid reading is not shown. For vertical alignment or alignment with the inclinometers switched off () , the angle readings will not appear. <i>Note - For the dimensions page, the centroid reading is not displayed as the lasers are switched on at full brightness which can lead to fluctuating readings at short distances.</i>
	Distance between measuring units, measured from the centres of the rods.
	Distance between the coupling and the measuring unit on the movable machine. This automatically defaults to half the distance between the measuring units, however, if necessary, you can enter a more accurate distance for your machine setup.
	Distance between the measuring unit and the front foot of the movable machine (centre of foot). Note that this may be negative, if necessary.
	Distance between the front and back feet of the movable machine (centre of feet).
	The Next Screen icon, takes you to the next step in the alignment process (available only when the required dimensions are entered).

- Enter the required dimensions, and select the Next Screen icon in the right panel. The **Alignment Tolerances** screen displays.
 - You can proceed to the next step without entering the foot dimensions. You will be prompted later to specify the foot dimensions if they are required.

View Options





When entering dimensions for an alignment, you must first configure the display unit so that the displayed machine train image matches the actual machine setup being aligned. The **Dimensions** screen's View Options icon allows you to make the following changes to the displayed image.

-  Select the View Options icon to access View Options.



Figure 5 - 4. View Options.

View options are described in the following table.

Icon	Status
	If necessary, switch the A and B measuring units to match their actual mounting on the stationary and moveable machines.
	If necessary, switch which machine is stationary and which will be moved to correct the misalignment. Note that you can change this designation later if required.
	If necessary, switch the viewing perspective, as if viewing the machine train from the opposite side. Use this so that the displayed arrangement corresponds to how you are looking at the machine train while you perform the alignment.
	Hide the View Options icons.

Alignment Tolerances

With a Quick Alignment, alignment targets are set to 0, 0, which indicate perfectly aligned shafts. On the **Alignment Tolerances** screen, specify how to measure angular misalignment, and the alignment tolerances (i.e., how close you must get to the 0, 0 alignment targets).

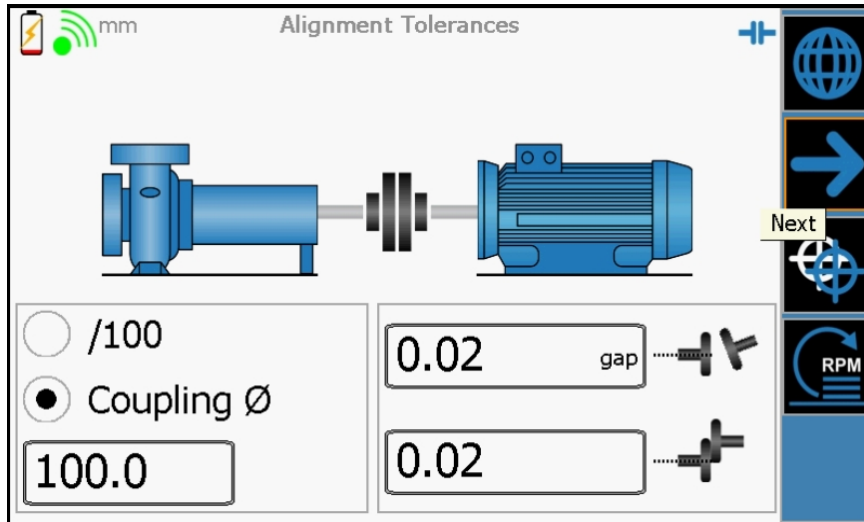
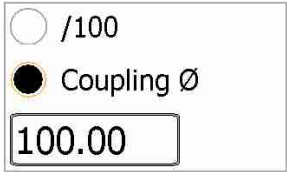





Figure 5 - 5. The **Alignment Tolerances** Screen.

Alignment tolerance options are overviewed in the following table.

Icon / Menu	Description
	Specify whether to measure angular misalignment relative to a fixed distance or as a proportion of the coupling diameter (Coupling \varnothing). If /100 is selected, enter tolerances using units specified in the units of measurement Settings screen (for Metric units - mm / 100 mm); for English units mil/in or mil/ft . If Coupling \varnothing is selected, an additional numeric entry field displays, allowing you to enter the coupling diameter in the specified length units.
 	Enter the angular tolerance for your alignment job. Enter the offset tolerance for your alignment job.
	Displays the Target Setup screen. The default alignment targets for Quick Alignment jobs are 0, 0. The Target Setup screen allows you to enter specific alignment targets other than 0, 0. This is typically done to adjust for a cold alignment to allow for thermal expansion, or for mechanical expansion.
	Provides access to a tolerance table based on machine RPM. See the Tolerance Table section below for details.

- First, select whether to measure angular misalignment relative to a fixed distance (e.g., mm / 100 mm or mil / 1 in) or as a proportion of the coupling diameter (i.e., measure angular misalignment as coupling gap).
- Next, enter the angular and offset tolerances for your alignment job.

During the alignment job:

- ✓ When measurement results are within the specified tolerance, they are displayed with a green check mark.
 - ⚡ When measurement results are between 1x and 2x the specified tolerance, they are displayed with an amber wavy-lines mark.
 - ✗ When measurement results are more than twice the specified tolerance, they are displayed with a red cross.
- Select the Next Screen icon in the right panel. The **Measurement** screen displays.

Tolerance Table

Range	RPM	Angular /100	Offset mm
I	0 - 2000	0.08	0.10
II	2001 - 3000	0.07	0.07
III	3001 - 4000	0.06	0.05
IV	> 4000	0.05	0.05
V	CUSTOM1	0.15	0.10
VI	CUSTOM2	0.25	0.10

Figure 5 - 6. The Tolerance Table

Icon / Menu	Description
①	Range selection buttons – tap to select the tolerance range to use (I-VI). The selected/active range is highlighted.
②	Range label/machine speed.
③	Angular tolerance value.
④	Offset tolerance value.
⑤	The last two ranges in the table (V & VI) can be used to enter custom values that are saved on the unit and will be available for all jobs.

This screen enables you to specify the permitted alignment tolerances (angular and offset) by selecting from a table of entries based on RPM.

How to Perform a Quick Alignment (Horizontal)

Recording the As-Found Measurements

After setting up your alignment job, you are ready to begin recording your initial, as-found alignment measurements. Measurements can be taken at any “clock” positions, for example:

- Reading 1 – 9 o'clock
- Reading 2 – 12 o'clock
- Reading 3 – 3 o'clock

The sequence of the three measurements should be 9-12-3 or 3-12-9, so that the shafts are always rotated in the same direction between measurements.

The above clock positions (9, 12, and 3 o'clock) are the most common for alignment measurements, however, measurements can be taken from any clock position. Also, while the 90 degree rule states that it is strongly recommended to take measurements that are 90 degrees apart, the TKSA 60 / 80 Alignment Tools will accept a minimum rotation angle of 30 degrees from the previous measurement position.

If the inclinometers have been switched off , then the measurement positions are fixed at 9-12-3. The display unit shows a position measuring units popup to instruct you to move the measuring units to each clock position when required:

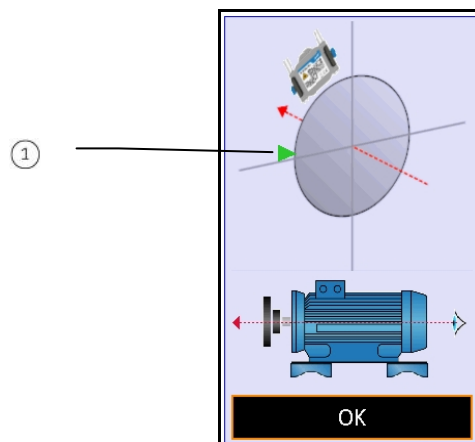

Figure 5 - 7. Position Measuring Units Popup

- ① Required clock position (as viewed from behind the moveable machine).
- Press the OK button when measuring units are in position.

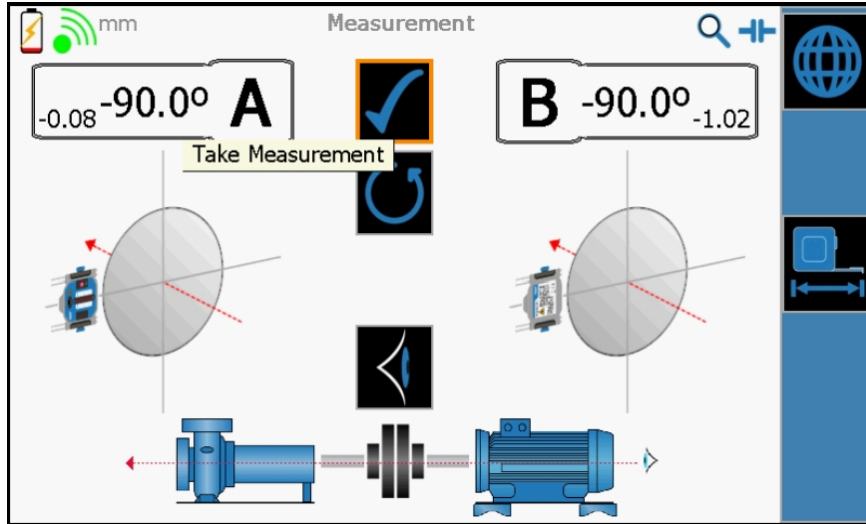
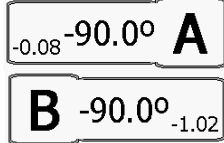









Figure 5 - 8. The Initial **Measurement** Screen (Measurement 1 of 3).

The **Measurement** screen allows you to collect three as-found measurements that are used to calculate the alignment across the coupling. Readings from the two measuring units (**A** and **B**) are displayed. The readings show the displacement measured by each measuring unit, allowing you to view the relative movement between the two measuring units; and the angle at which the measuring unit is sitting.

Measurement screen items are overviewed in the following table.

Icon / Menu	Description
	Displays the A and B measuring units' current displacement and angle. <ul style="list-style-type: none"> ➤ If the inclinometers have been switched off , then the measuring unit angle will not display..
	Indicates your viewing perspective to the machine shaft, relating to the angle of the measuring units.
	Select to record the measurement. This icon only displays when a measurement can be taken (i.e., the measuring units are aligned and have been moved enough from the previous readings).
	Discards the last recorded measurement, allowing you to retake the measurement.
	If necessary, switch the viewing perspective, as if viewing the machine train from the opposite end.

Icon / Menu	Description
	When the three measurements have been collected, the Next Screen icon displays in the right panel menu, allowing you to progress to the next step.
	If necessary, select to return to the Dimensions screen (e.g., if you need to check or correct the entered dimensions).

If the angular position of the two measuring units is not the same, then warning icons display for the measuring units (see next figure).

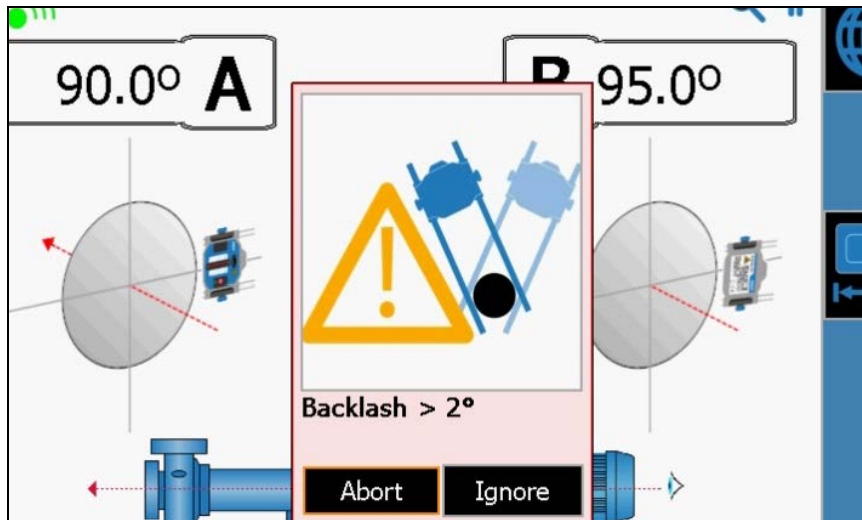



Figure 5 - 9. Example of Measuring Units Angular Position Not Being Similar.

To record the as-found alignment measurements:

-  With the measuring units in their first position (e.g., 3 or 9 o'clock), select the checkmark icon to record your first measurement. A two headed arrow prompts you to move the measuring units to the next measurement position.

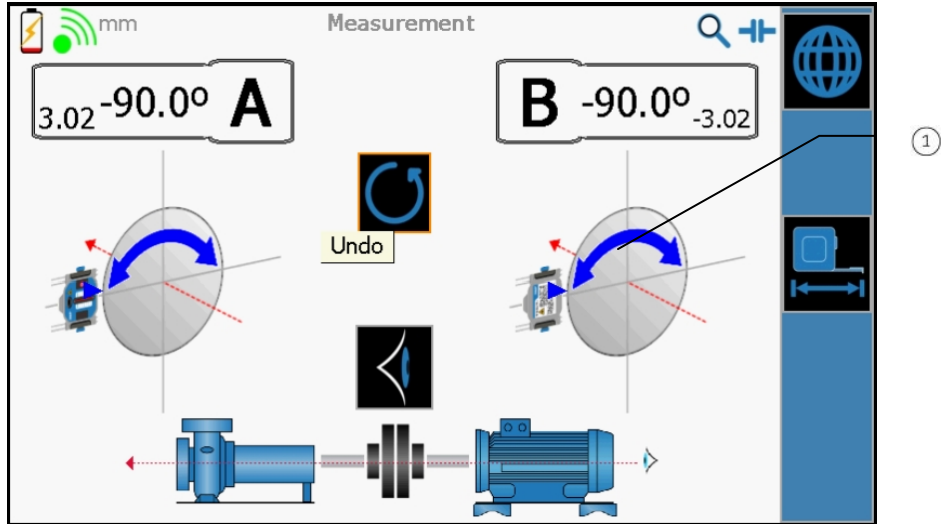

Figure 5 - 10. Example of Prompt to Move Measuring Units.

① prompt to move measuring units

- Move the measuring units to their second position. The **Measurement** screen updates to display the new position and current readings.

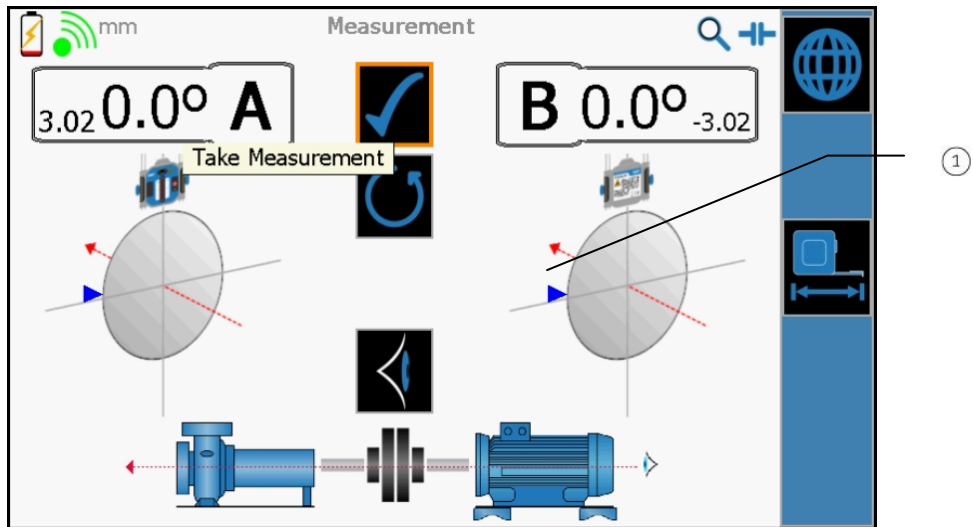



Figure 5 - 11. Measurement 2 of 3.

① indicates a previous recorded measurement.

- If the measuring units are not moved sufficiently from their initial positions, you are again prompted to move the units.

-  With the measuring units in their second position, select the checkmark icon to record the second measurement. You are prompted to move the measuring units to the next measurement position.

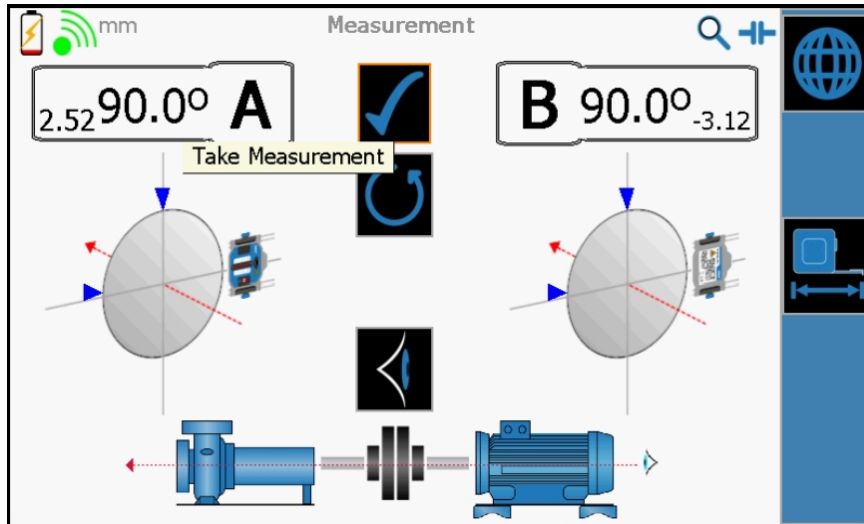



Figure 5 - 12. Measurement 3 of 3.

-  With the measuring units in their third position, select the checkmark icon to record the third measurement. The Next Screen icon displays in the right panel.
- Select the Next Screen icon to continue. The **Select Inspection** screen displays and prompts whether another inspection is required (if additional inspections are enabled in the **Settings** screen).



How to Perform Additional Inspections

Overview

To perform additional inspections, ensure that the additional inspections setting is enabled on the **Settings** screen prior to starting the job:

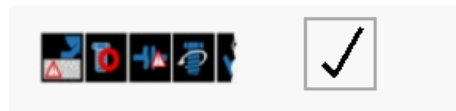

If the additional inspections setting is enabled, you are provided an opportunity to select additional inspections to perform as part of the overall job after performing the initial alignment measurements. When selecting and performing additional inspections, each inspection is carried out for each machine in the machine train (moving from left to right). After completing an inspection for all machines in the machine train, you may select another inspection and repeat the process. Some inspections are only valid for certain types of machines, therefore, some machines may be skipped for some inspections. For inspections that require the laser measuring units, you will be prompted to input necessary machine dimensions, if you haven't previously input them.

With a Quick Alignment job, the recommended order in which to perform additional inspections is:

- Foundation status
- Washer / bolt status
- Machine and coupling wear status
- Oil leaks
- Oil level
- Bolt torque: should be inspected as found before loosening any bolts
- Run out
- Soft foot
- Shims / Chocking height

The **Select Inspection** screen allows you to select additional inspections to perform as part of a Quick Alignment job. The available inspections vary depending on features that you have licensed. Contact your SKF sales associate if you wish to license additional features.

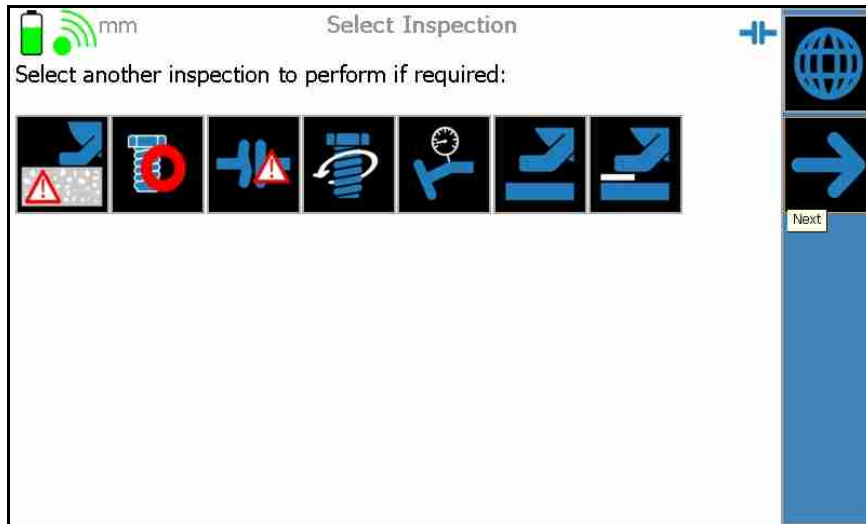









Figure 5 - 13. An Example **Select Inspection** Screen.

Select Inspection options are overviewed in the following table and detailed later in this chapter.

Icon	Description
	Check machine foundation status
	Check bolt / washer status
	Check for general machine and coupling wear
	Inspect current shim arrangements

Icon	Description
	Check torque for foundation bolts
	Check for shaft runout
	Test for soft foot conditions

- Select the appropriate inspection option(s) and perform the selected inspection(s).

In this chapter, for example purposes, we'll select to perform a **Shaft Runout** inspection, a **Laser Soft Foot** inspection, and a **Shims / Chocking Height** inspection. Alignment results are described after these inspection sections.

Shaft Runout Inspection

The Shaft Runout Inspection allows you to record the maximum shaft runout measured from dial gauges placed at various positions along each machine's shaft.

To begin the shaft runout inspection:

-  Select the **Shaft Runout** inspection icon, the **Runout Inspection** screen displays.

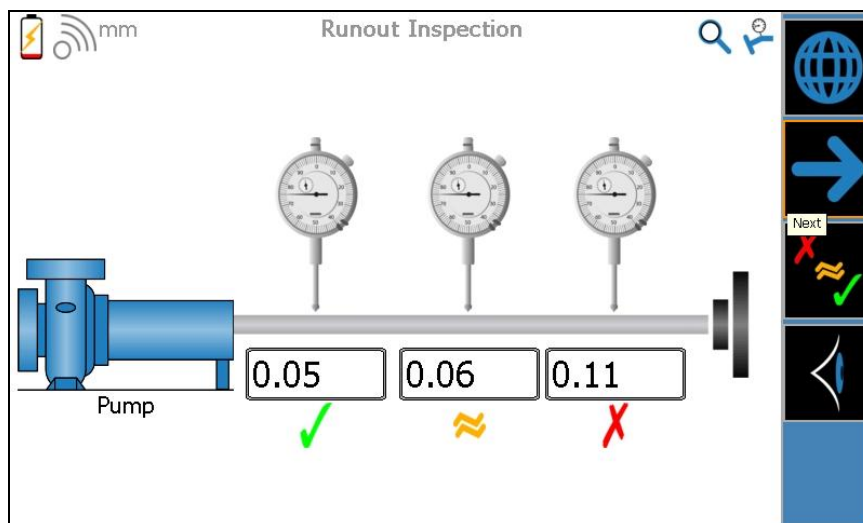





Figure 5 - 14. The **Runout Inspection** Screen.

During the inspection, the above screen displays for both machines in the machine train, allowing you to perform the inspection for both machines.



The **Runout Inspection** screen's right panel menu icons are similar for most inspections and are overviewed in the following table.

Icon	Description
	If necessary, switch the viewing perspective, as if viewing the machine train from the opposite side.
	Displays the Runout Tolerance screen where you enter the shaft's runout tolerance. Runout measurement results are compared to the entered runout tolerance.
	After entering all measurements for the first machine's shaft, select the Next Screen icon to repeat the measurements for the other machine in the machine train, or, after entering data for both machines, to redisplay the Select Inspection screen, so you may select another inspection.

To record as-found shaft runout measurements:

- 
 Select the right panel's Tolerance icon and enter the shaft's runout tolerance. Then select the Next Step icon to return to the **Runout Inspection** screen.
- On the **Runout Inspection** screen, enter the shaft's runout measurements (the dial gauge's maximum readout at the shaft position).

The entered measurements are compared to the shaft's runout tolerance and measurement results display as:

-  When measurement results are within the specified tolerance.
-  When measurement results are between 1x and 2x the specified tolerance.
-  When measurement results are more than twice the specified tolerance.
- After entering shaft runout measurements for the first machine's shaft, select the right panel's Next Screen icon and repeat the procedure for the other machine's shaft.
- After entering shaft runout measurements for both shafts in the machine train, select the right panel's Next Screen icon. The **Select Inspection** screen re-displays, allowing you to select another inspection.
 - Since you've now performed the inspection, its icon no longer displays on the **Select Inspection** screen.

 **Laser Soft Foot Inspection**

Important! - When you select the soft foot inspection, you are prompted that the "Inspection requires bolts to be loosened, which will invalidate other inspections." For this reason, it is recommended to perform other required machine inspections prior to performing the Soft Foot inspection.

The **Laser Soft Foot** inspection allows you to check for soft foot conditions using the TKSA 60 / 80 laser measuring units.

- Using laser soft foot vs. manual soft foot is specified on the main **Settings** screen.

To begin the laser soft foot inspection:

-  From the **Select Inspection** screen, select the **Soft Foot** inspection icon. The **Dimensions** screen displays and prompts you to enter machine dimensions for the *stationary* machine in the machine train (you've previously entered dimensions for the moveable machine).

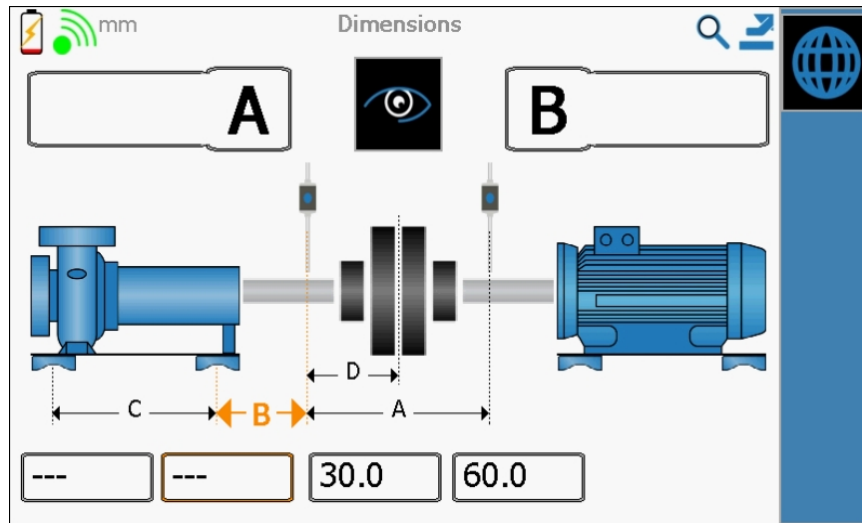

Figure 5 - 15. The Stationary Machine's **Dimensions** Screen.

- Enter the foot dimensions for the stationary machine, and select the right panel's Next Step icon to proceed. The **Laser Soft Foot** screen displays.

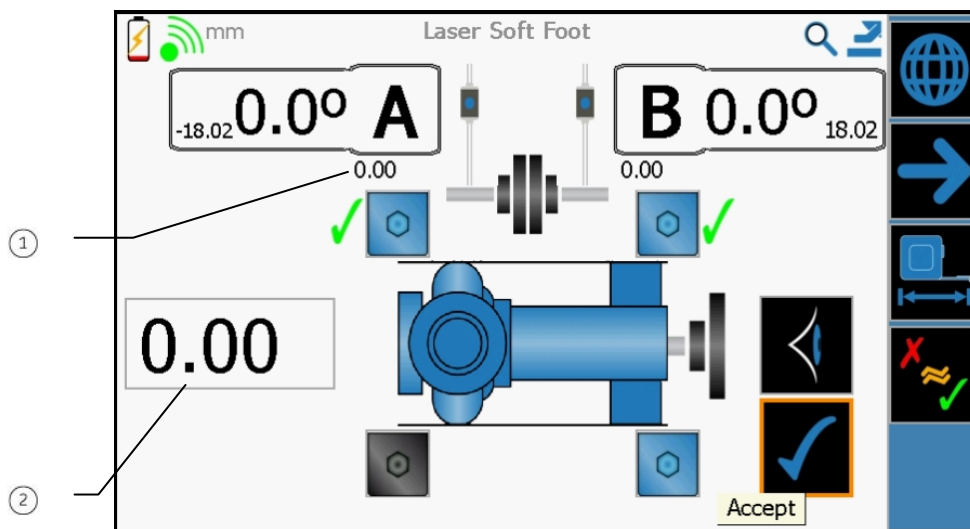



Figure 5 - 16. The **Laser Soft Foot** Screen.

- ① previously recorded soft foot displacement value for foot
- ② current machine foot's (grayed foot) soft foot displacement value

During the inspection, the above screen displays for both machines in the machine train, allowing you to perform the inspection for both machines.

Laser procedure for measuring soft foot conditions:

- Place the measuring units at the 12:00 o'clock position.
-  Select the right panel's **Tolerances** icon, the **Soft Foot Tolerance** screen displays.
- Enter the machine's soft foot tolerance, and then select the right panel's Next Step icon to return to the **Laser Soft Foot** screen.
- Follow the prompts on the screen to record the soft foot displacement condition for each machine foot.
For the specified machine and machine foot, loosen the bolts. As you loosen the bolts, the measuring units detect change in movement resulting from a soft foot condition and the resulting foot displacement is displayed in the large numeric box adjacent to the machine graphic.
-  When the bolt is completely loose, select the checkmark icon to record the final displacement value. The final displacement value in the large numeric box moves adjacent to the machine foot for which it was recorded. Then, re-tighten the bolt to the correct torque and follow the same procedure for the remaining machine feet.

Measured soft foot displacement values are compared to the machine's soft foot tolerance and measurement results display as:

- ✓ When measurements are within the specified tolerance.
- ≈ When measurements are between 1x and 2x the specified tolerance.
- ✗ When measurements are more than twice the specified tolerance.
- After recording soft foot measurements for the first machine in the machine train, select the right panel's Next Screen icon and repeat the procedure for the other machine.
- After recording soft foot measurements for both machines in the machine train, select the right panel's Next Screen icon. The **Select Inspection** screen re-displays, allowing you to select another inspection.
 - Since you've now performed the inspection, its icon no longer displays on the **Select Inspection** screen.



Shims / Chocking Height Inspection

For machines that use either shims or chocks to adjust the foot height, the Shims Inspection allows you to record how much each foot has been shimmed. On the **Shims Inspection** screen, the shimming arrangement for each foot is displayed as a stack of shims or chocks of varying thicknesses.

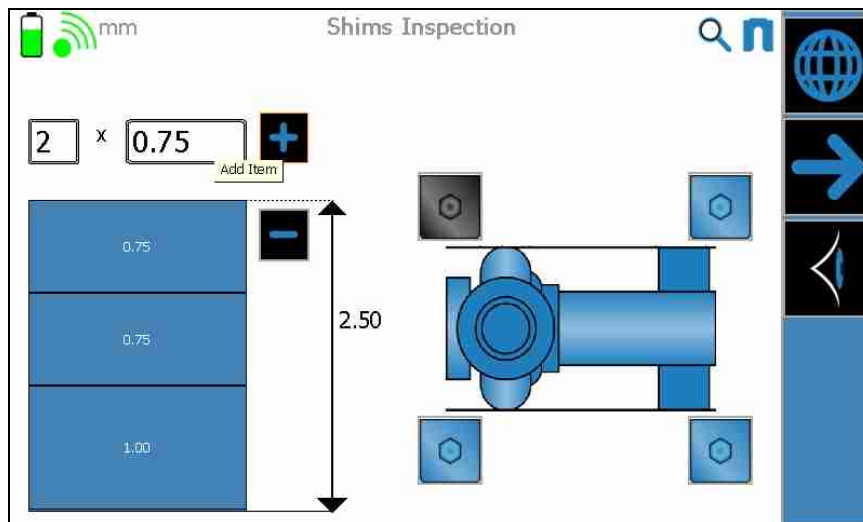

Figure 5 - 17. The **Shims Inspection** Screen.

During the inspection, the above screen displays for both machines in the machine train, allowing you to perform the inspection for both machines.

To enter Shim Inspection information:

- The shim stack is entered separately for each foot.
- For the specified machine and machine foot, enter the number of shims of a specified thickness that are used for the machine foot (e.g., enter **2 x 0.05** if the foot has 2 shims that are 0.05 mm thick) and then select the **+** icon to add them to the shim stack. If necessary, select the **-** icon to remove the top shim from the stack.
- Repeat for all feet for the specified machine.
- After recording shim arrangements for the first machine in the machine train, select the right panel's Next Screen icon and repeat the procedure for the other machine.
- After recording shim arrangements for both machines in the machine train, select the right panel's Next Screen icon. The **Select Inspection** screen re-displays, allowing you to select another inspection.
 - Since you've now performed the inspection, its icon no longer displays on the **Select Inspection** screen.
- After completing the as-found alignment measurements and any selected inspections, from the **Select Inspection** screen, select the right panel's Next Screen icon, the **Alignment Results** screen displays..

How to View Alignment Results (Horizontal)

After performing as-found measurements for the alignment inspection and, if selected, all additional inspections, the next step is to view measurement results for the inspections performed, beginning with alignment inspection results. As you view each inspection's results, you are provided an opportunity to specify whether corrections are necessary.

The alignment results screen displays angular and offset alignment measurement results for both the vertical (left) and the horizontal planes (right).

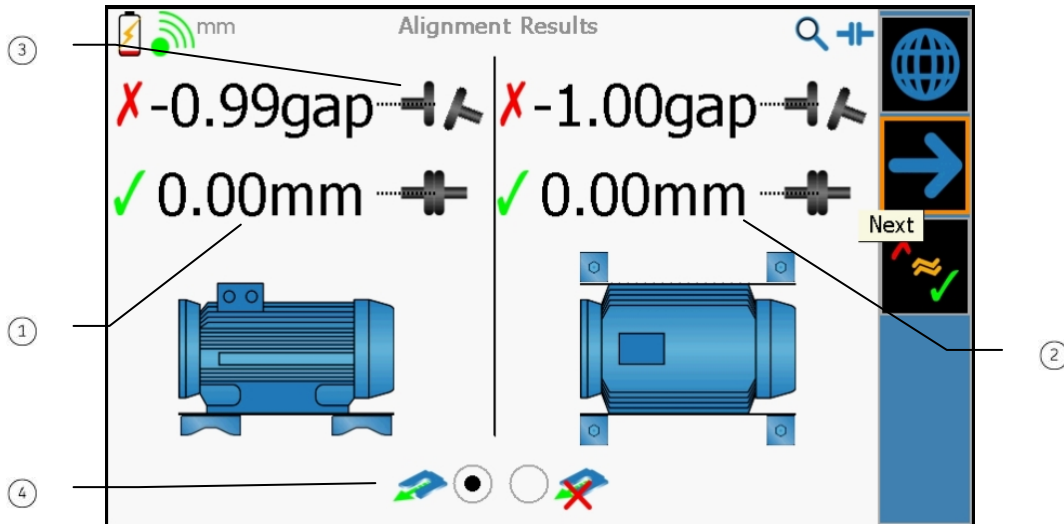



Figure 5 - 18. The **Alignment Results** Screen.

- ① vertical alignment results
- ② horizontal alignment results
- ③ coupling position icon
- ④ correction / no correction icons

For each measurement plane, angular and offset alignment results display graphically with a coupling position icon that shows the coupling's current position as viewed from the respective plane; and numerically in the specified units of measurement. Measurement results with respect to alignment tolerances display as:

- ✓ When measurement results are within the specified tolerance.
- ⚡ When measurement results are between 1x and 2x the specified tolerance.
- ✗ When measurement results are more than twice the specified tolerance.

Based upon vertical and horizontal alignment results, choose whether to correct the machinery alignment or to leave it as-found:

-  Select the "correction" icon if you wish to correct the machinery alignment (default setting if tolerances are exceeded), or

-  Select the “no correction” icon to leave the machinery alignment as-found (default setting if tolerances are not exceeded). Then press the right panel’s Next Screen icon to progress to the next inspection’s results.

Runout Results

The **Runout Results** screen displays results for the first machine’s shaft runout inspection.

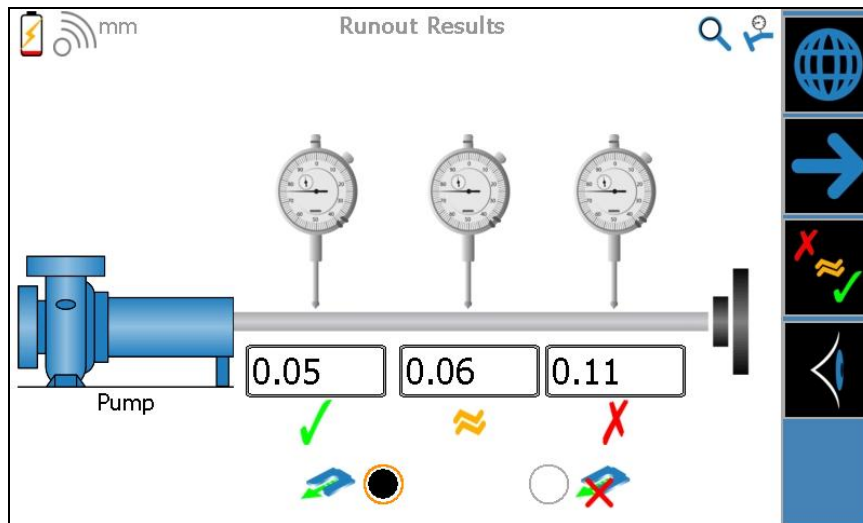



Figure 5 - 19. The **Runout Results** Screen.

Based upon the shaft runout results, choose whether to correct the runout or to leave it as-found:

-  Select the “correction” icon if you wish to correct the runout, or
-  Select the “no correction” icon to leave the runout as-found. Then press the right panel’s Next Screen icon to progress to the other machine’s runout results.
- After reviewing runout results for both machines in the machine train, select the right panel’s Next Screen icon to progress to the next inspection’s results.

Soft Foot Results

The **Soft Foot Results** screen displays results for the first machine's soft foot inspection.

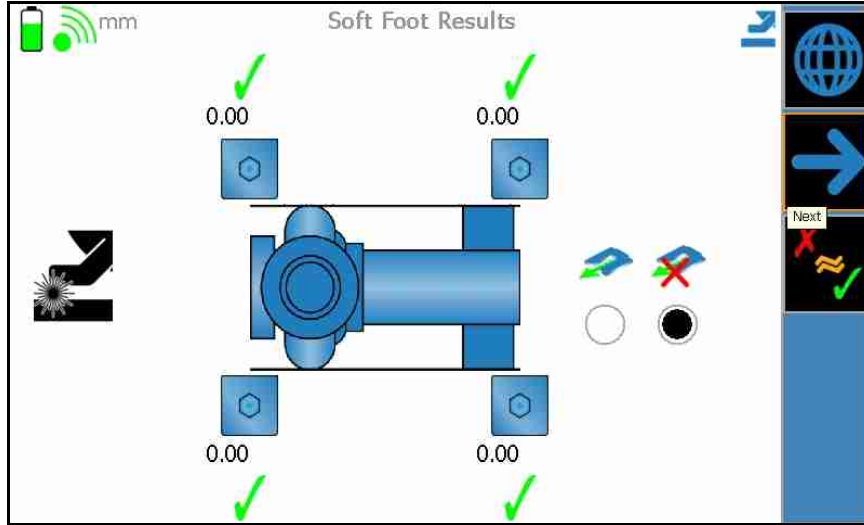



Figure 5 - 20. The **Soft Foot Results** Screen.

Based upon the soft foot results, choose whether to correct any soft foot condition or to leave it as-found:

-  Select the “correction” icon if you wish to correct the soft foot condition, or
-  Select the “no correction” icon to leave the soft foot condition as-found. Then press the right panel's Next Screen icon to progress to the other machine's soft foot results.
- After reviewing soft foot results for both machines in the machine train, select the right panel's Next Screen icon to progress to the next inspection's results.
- After reviewing inspection results for all performed inspections (including alignment) and selecting whether to make corrections, press the right panel's Next Screen icon to progress to the **Corrections** screen (if alignment corrections were specified) and/or to the Measurement screen for those inspections where corrections were specified. If corrections were not selected for any inspection's results, then you advance to the **Job Report** screen.

How to Correct As-Found Conditions and Verify Corrections (Horizontal)

If you specified corrections for multiple inspections, the order in which corrections are performed is automatically optimized by the TKSA 60 / 80 alignment process. Therefore, depending on which inspections / corrections were specified, corrections will be performed as sequenced below:

- Run out
- Soft foot
 - It is important to correct run out and soft foot before attempting to correct alignment.
- Alignment
- Foundation status
- Washer / bolt status
- Wear status
- Bolt torque
- Oil leaks
- Oil level

Alignment Corrections (Horizontal)

Vertical and horizontal **Alignment Corrections** screens display alignment correction information for vertical and horizontal machinery alignment movements. **Alignment Corrections** screens are “live” displays that automatically update their displayed angular and offset alignment results and their alignment correction information as you move the machine, to show how your machine “moves” are affecting shaft alignment in real time.

Which **Alignment Corrections** screen displays (vertical or horizontal), depends on the position of the measuring units.

- For vertical alignment corrections, place the measuring units in the 12 o'clock position.
- For horizontal alignment corrections, place the measuring units in either the 3 o'clock or 9 o'clock position.

If the inclinometers have been switched off , then the display unit will initially instruct the user to move the heads to the 12 o'clock position to perform the vertical alignment corrections. When the vertical corrections have been completed, the “Switch Plane” button



should be clicked to initiate a switch to horizontal corrections. The display unit will then instruct the user to move the measuring units to the 9 o'clock position.

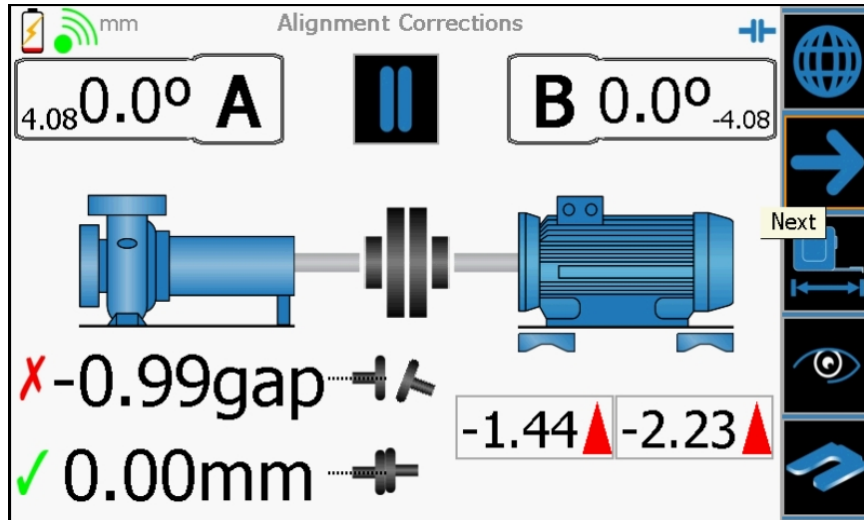

Figure 5 - 21. An Example Vertical **Alignment Corrections** Screen.

Typically, vertical corrections are performed first, as vertical moves typically affect the machine's horizontal alignment more so than the other way around. In most cases, as it is difficult to isolate movement to one plane, you will have to perform moves in each plane a couple of times to align the machine within tolerances.











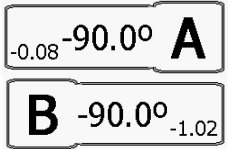

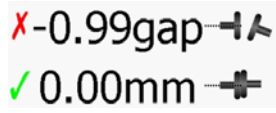
The vertical **Alignment Corrections** screen above displays when the measuring units are positioned at 12 o'clock. The vertical plane's angular and offset misalignment results display (bottom left) along with vertical correction movement information that will correct the vertical misalignment (bottom right).

In the example above, the angular misalignment gap requires correction. The angular results coupling icon displays a graphical representation of how the coupling is currently aligned when viewed from the vertical plane, the alignment results icon indicates that the current angular alignment results are more than twice the specified tolerance (red X), and the alignment correction information shows that both the front and rear feet must be raised (arrowheads pointing up) but the rear feet must be raised more than the front feet.

Again, alignment measurement results with respect to alignment tolerances display as:

- ✓ When measurement results are within the specified tolerance.
- ≈ When measurement results are between 1x and 2x the specified tolerance.
- ✗ When measurement results are more than twice the specified tolerance.
 - The correction arrowhead's color also indicates alignment results with respect to tolerances, using the same indicating colors and ratings as the alignment results icons above.

The **Alignment Corrections** screen's information and right panel menu icons are overviewed in the following table.

Icon / Menu	Description
	<p>Displays the A and B measuring units' current displacements and angles.</p> <ul style="list-style-type: none"> ➤ If the inclinometers have been switched off , then the measuring unit angle will not display.
	<p>Angular and offset alignment results for the displayed plane. Coupling icons display a graphic representation of the current alignment condition. Alignment results icons indicate alignment results compared to specified tolerances.</p>
	<p>For the displayed plane, the amount and direction of foot correction movement required for the machine's front and rear feet. Arrowhead direction indicates direction of movement, arrowhead color indicates alignment results compared to specified tolerances.</p>
	<p>Pause / start live updates on the screen. This is useful when you need to keep the initial correction values on the screen for reference as you move the machine. For example, if you need to jack up a machine to add / remove shims, this feature allows you to pause live updates, jack the machine up, add / remove shims, lower the machine, then restart live updates to view the affect your move had on the machine's alignment.</p>
	<p>Switch view to horizontal correction plane or vertical correction plane.</p> <ul style="list-style-type: none"> ➤ Only available if the inclinometers have been switched off .
	<p>After making both vertical and horizontal corrections, select the right panel's Next Screen icon to:</p> <ul style="list-style-type: none"> - If no other inspection corrections were specified, progress to the Measurement screen, allowing you to re-perform your alignment measurements, to verify the results of your corrections. - If other inspection corrections were specified, progress to the measurement screen for those inspections requiring correction.
	<p>If necessary, select to return to the Dimensions screen (e.g., if you need to check or correct the entered dimensions).</p>
	<p>Select the View Options icon to access View Options. Available options are:</p> <ul style="list-style-type: none">  If necessary, switch which machine is stationary and which will be moved to correct the misalignment.  If necessary, switch the viewing perspective, as if viewing the machine train from the opposite side.
	<p>Displays the Shims Inspection screen, allowing you to update the machine's shim / chock data after your machinery moves.</p>

In our example, we're aligning the vertical plane first.

- For the vertical plane, add or remove shims to move the machine in the specified direction by the specified amount of movement. As you move the machine, the angular and offset alignment results, and the machinery movement indicators update to show the results of your movements.

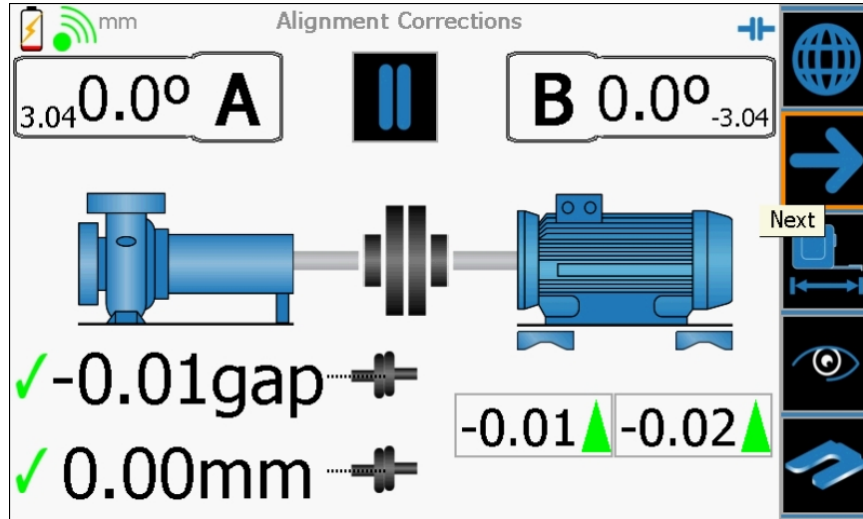



Figure 5 - 22. Vertical **Alignment Corrections** Screen After Alignment Correction Moves.

- When your vertical machinery movements result in angular and offset results that are within the specified targets and tolerances, move the measuring units to either the 3 o'clock or 9 o'clock position to display horizontal plane's **Alignment Corrections** screen or if the inclinometers are switched off , press the switch plane icon  and follow the on screen prompts.

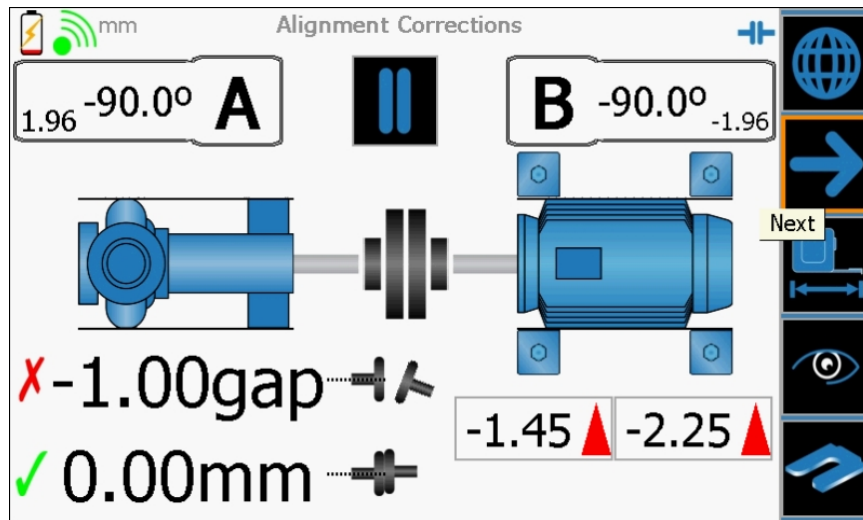

Figure 5 - 23. Horizontal **Alignment Corrections** Screen Before Machinery Correction Moves.

The horizontal **Alignment Corrections** screen displays when the measuring units are positioned at either the 3 o'clock or 9 o'clock position. Again, the horizontal plane's angular and offset misalignment results display (bottom left), this time with lateral machinery movement information that will correct the horizontal misalignment (bottom right).

- This view shows the user standing with the machine in front of him, side on, so moves are either toward or away from the user's viewpoint.

In the example above, the angular misalignment gap again requires correction. The alignment results icon again indicates that the current angular alignment results are more than twice the specified tolerance (red X), and the machinery move information shows that both the front and rear feet must be moved away from you (red arrowheads pointing away from your viewpoint), but the rear feet must be moved more than the front feet.

- For the horizontal plane, move the machine in the specified direction by the specified amount of movement. As you move the machine, the angular and offset alignment results, and the machinery movement indicators again update to show the results of your movements.

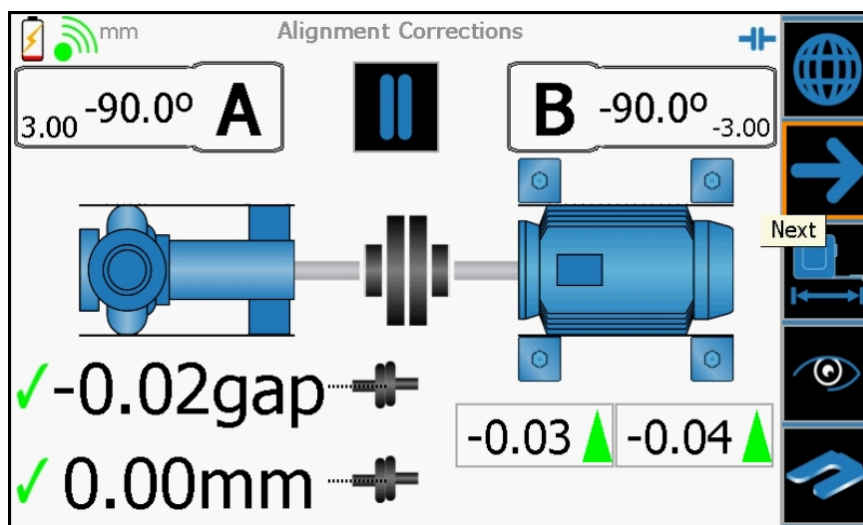



Figure 5 - 24. Horizontal **Alignment Corrections** Screen After Machinery Correction Moves.

- After correcting the machine's horizontal alignment to within tolerances, we typically move the measuring units back to the 12 o'clock position to again view the vertical plane's **Alignment Corrections** screen, to determine if our horizontal movements affected our vertical alignment. If so, perform the required corrections, and then recheck the horizontal plane. Repeat until alignment values for both planes are within tolerances. If the inclinometers are switched off , press the switch plane icon and follow the on screen prompts to switch to vertical or horizontal correction view:



- After all alignment values are within tolerances, select the right panel's Next Screen icon to progress to measurement screens for any remaining inspections that require correction.
- After performing corrections and recording as-corrected measurements for these additional inspections, you progress to the alignment **Measurement** screen, where you measure and record the as-corrected alignment. This allows you to verify that your alignment is still within tolerances after all machinery corrections have been finalized.

Additional Inspection Corrections

Correction screens for additional inspections look very much like the inspection's initial measurement screen. This allows you to correct the inspection issue that required correction, and re-measure to verify and record your correction results.

- Perform corrections and re-measure the as-corrected condition for all additional inspections that require correction.
 - Note that if the as-corrected measurement results still exceed your specified tolerances, you are *not* provided a second opportunity to specify additional corrections are necessary.
- After alignment and all additional inspections are corrected, you advance to the alignment **Measurement** screen, allowing you to measure as-corrected alignment conditions and record the results.
- After recording the as-corrected alignment measurements, press the right panel's Next Screen icon, the **Alignment Results** screen displays, showing vertical and horizontal alignment results after correction. At this point you can choose to make more alignment corrections if required or proceed to saving the job if no more corrections are necessary.
- If, after reviewing the as-corrected alignment results, you are satisfied that no further corrections are required, press the right panel's Next Screen icon to view the **Job Save** screen.

How to Set Up a Quick Alignment (Vertical)

The following sections detail portions of the alignment process that are different for a vertical alignment job vs. a horizontal alignment job.

To set up a vertical Quick Alignment:

- From the Home screen, select the Quick Alignment icon. The **Quick Alignment Menu** screen prompts you for the orientation of machine train on which you are performing the alignment, **Horizontal** or **Vertical**.

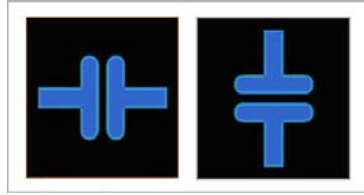

Figure 5 - 25. Horizontal or Vertical Alignment Icons.

- Specify to perform a vertical alignment. The machine **Dimensions** screen displays.

Specifying Machine Dimensions

Ideally, it is best to position the measuring units and line up the lasers before you enter the machine dimensions. You should align the measuring units as best as possible, including fine adjustments the brackets as necessary. You should perform this alignment before measuring anything to provide the most accurate results possible.

Also, make sure the laser beam is hitting the sensor far enough away from the edges so that it will not drop off the top/bottom of the sensor as the user rotates the shaft.

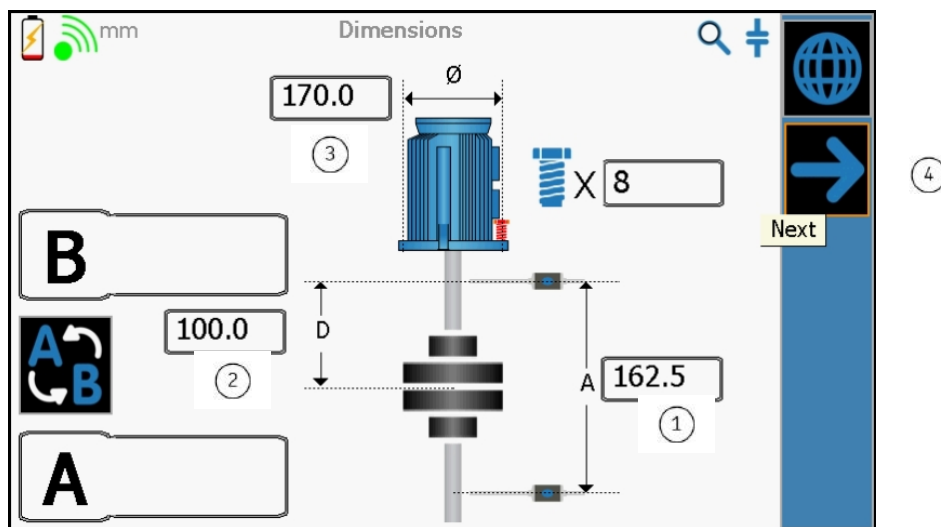



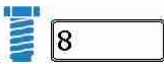





Figure 5 - 26. The Vertical Alignment **Dimensions** Screen.

Use the machine **Dimensions** screen to specify machine dimensions for the machines you are aligning. The specified dimensions are used in the alignment application's calculations.

The vertical alignment **Dimensions** screen shows the moveable machine and the coupling. The two measuring units (A and B) are also shown.

Dimensions screen items for vertical machine alignments are overviewed in the following table and discussed in detail later in this section.

Icon / Menu	Description
	Measuring Unit B position status. Displays the centroid reading on the sensor. If laser is not hitting the sensor, then the centroid reading is not shown. <i>Note - For the dimensions page, the centroid reading is not displayed as the lasers are switched on at full brightness which can lead to fluctuating readings at short distances.</i>
	Measuring Unit A position status. Displays the centroid reading on the sensor. If laser is not hitting the sensor, then the centroid reading is not shown. <i>Note - For the dimensions page, the centroid reading is not displayed as the lasers are switched on at full brightness which can lead to fluctuating readings at short distances.</i>
	If necessary, switch the A and B measuring units to match their actual mounting on the stationary and moveable machines.
	(Optional) Number of shimable bolts around the moveable machine. Required only if alignment correction is necessary.
	Distance between measuring units, measured from the centres of the rods.
	Distance between the coupling centre and the measuring unit on the movable machine. This automatically defaults to half the distance between the measuring units, however, if necessary, you can enter a more accurate distance for your machine setup.
	(Optional) The flange diameter. The diameter of the circle that the bolts make. Required only if alignment correction is necessary.
	The Next Screen icon, takes you to the next step in the alignment process (available only when the required dimensions are entered).

- Enter the required dimensions, and select the Next Screen icon in the right panel. The **Alignment Tolerances** screen displays.

Alignment Tolerances

With a Quick Alignment, alignment targets are set to 0, 0, which indicate perfectly aligned shafts. On the **Alignment Tolerances** screen, specify how to measure angular misalignment, and the alignment tolerances (i.e., how close you must get to the 0, 0 alignment targets).

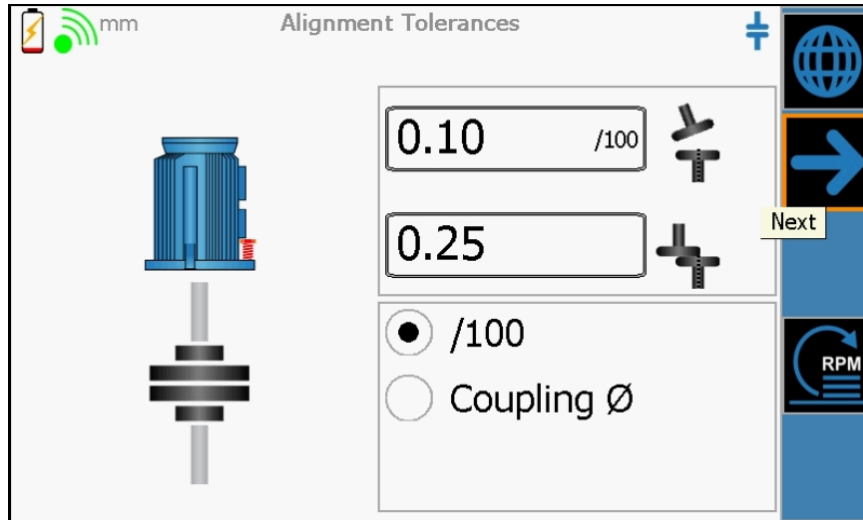





Figure 5 - 27. The Vertical **Alignment Tolerances** Screen.

Alignment tolerance options are overviewed in the following table.

Icon / Menu	Description
<input checked="" type="radio"/> /100 <input type="radio"/> Coupling Ø	Specify whether to measure angular misalignment relative to a fixed distance or as a proportion of the coupling diameter (Coupling Ø). If /100 is selected, enter tolerances using units specified in the units of measurement Settings screen (for Metric units - mm / 100 mm); for English units mil/in or mil/ft . If Coupling Ø is selected, an additional numeric entry field displays, allowing you to enter the coupling diameter in the specified length units.
0.10 /100  0.25 	Enter the angular tolerance for your alignment job. Enter the offset tolerance for your alignment job.
	Provides access to a tolerance table based on machine RPM.

- First, select whether to measure angular misalignment relative to a fixed distance (e.g., mm / 100 mm or mil / 1 in) or as a proportion of the coupling diameter (i.e., measure angular misalignment as coupling gap).
- Next, enter the angular and offset tolerances for your alignment job or select the tolerance table icon and select the required tolerances based on the machine RPM.

During the alignment job:

- ✓ When measurement results are within the specified tolerance, they are displayed with a green check mark.
- 🌀 When measurement results are between 1x and 2x the specified tolerance, they are displayed with an amber wavy-lines mark.

- X** When measurement results are more than twice the specified tolerance, they are displayed with a red cross.
- Select the Next Screen icon in the right panel. The **Measurement** screen displays.

How to Perform a Quick Alignment (Vertical)

Recording the As-Found Measurements

After setting up your alignment job, you are ready to begin recording your initial, as-found alignment measurements.

For vertical alignment, measurement positions are fixed in relation to the reference bolt and are always spaced 90 degrees apart. As you perform the measurements, make sure that you move the measuring units to the correct position before taking the measurement. The sequence of the three measurements should be so that the shafts are always rotated in the same direction between measurements.

- It is easiest to perform the measurement and optional correction if you are standing facing the shaft, with what will be the first measurement position on your right.

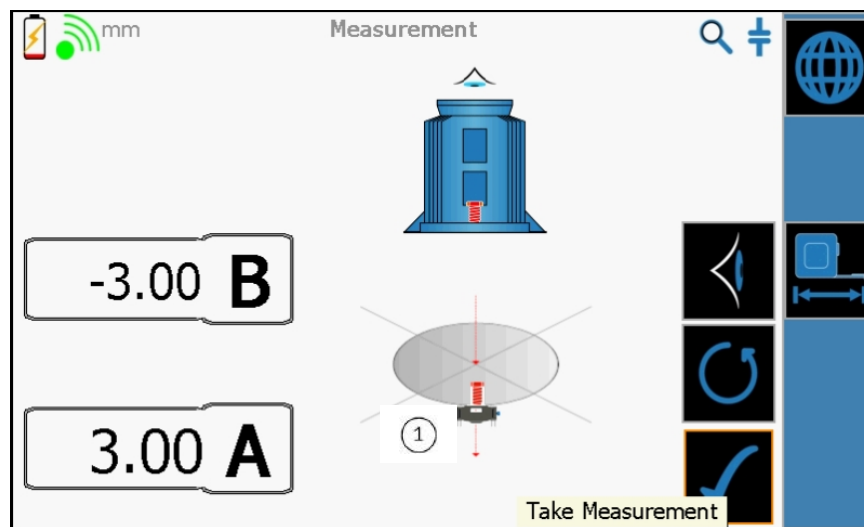

Figure 5 - 28. The Initial **Measurement** Screen (Measurement 1 of 3).

- ① indicates reference bolt location and the measuring units' first measurement position.

The **Measurement** screen allows you to collect three as-found measurements that are used to calculate the alignment across the coupling. Readings from the two measuring units (**A** and **B**) are displayed. The readings show the displacement measured by each measuring unit, allowing you to view the relative movement between the two measuring units.

Vertical alignment measurements are performed at specific points. The first measurement is typically performed at a location that is in-line with an arbitrary bolt. Hereafter, this location is referred to as the "reference" bolt. The second

measurement is performed 90 degrees from the reference bolt. The third measurement is performed 180 degrees from the reference bolt.

The display unit will show the following popup to instruct the user to move the measuring units to each position when required:

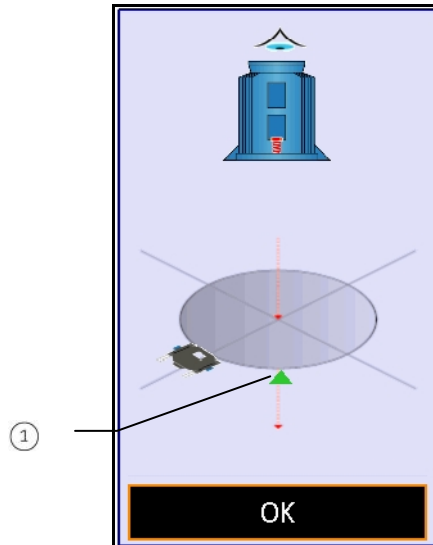



Figure 5 - 29. The Position Measuring Units Popup

- ① Required clock position (as viewed from above the moveable machine). Press the **OK** button when measuring units are in position.

Measurement screen items are overviewed in the following table.

Icon / Menu	Description
	Displays the A and B measuring units' current displacement.
	Indicates your viewing perspective to the machine shaft.
	Select to record the measurement. This icon only displays when a measurement can be taken (i.e., the measuring units are aligned and have been moved enough from the previous readings).
	Discards the last recorded measurement, allowing you to retake the measurement.
	If necessary, switch the viewing perspective, as if viewing the machine train with the reference bolt position directly in front of you, rather than to the right side.
	When the three measurements have been collected, the Next Screen icon displays in the right panel menu, allowing you to progress to the next step.

Icon / Menu	Description
	If necessary, select to return to the Dimensions screen (e.g., if you need to check or correct the entered dimensions).

To record the as-found alignment measurements:

-  With the measuring units in their first position, select the checkmark icon to record your first measurement. A **Position Measuring Units** popup prompts you to move the measuring units to the next measurement position, and the measurement unit indicator moves 90 degrees to indicate the next correct position.
- Move the measuring units to their second position.

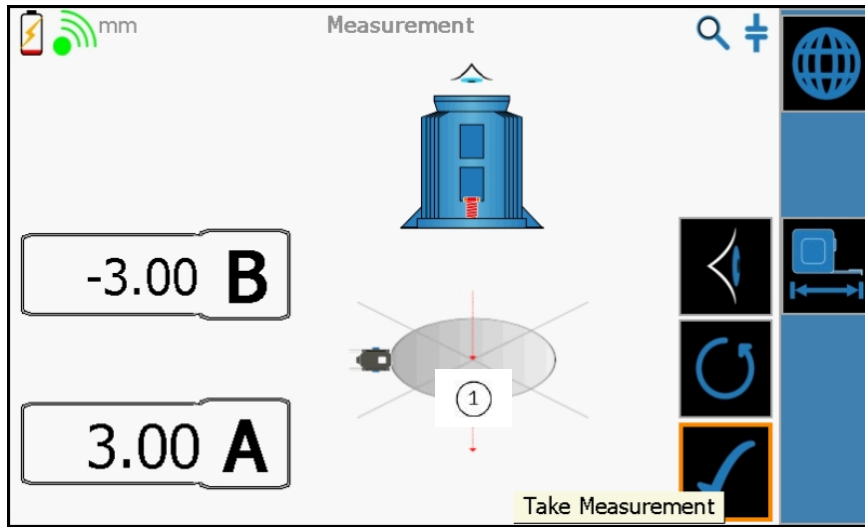



Figure 5 - 30. Measurement 2 of 3.

① indicates a previous recorded measurement.

-  With the measuring units in their second position, select the checkmark icon to record the second measurement. You are prompted to move the measuring units to the next measurement position.

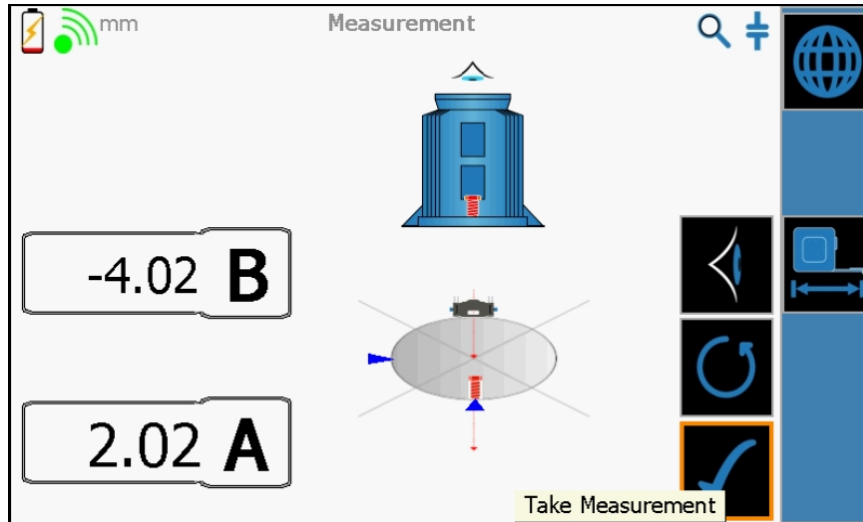



Figure 5 - 31. Measurement 3 of 3.

-  With the measuring units in their third position, select the checkmark icon to record the third measurement. The Next Screen icon displays in the right panel.
 - Select the Next Screen icon to continue.

How to View Alignment Results (Vertical)

After performing as-found measurements for the alignment inspection the next step is to view alignment inspection results. You are provided an opportunity to specify whether corrections are necessary.

The alignment results screen displays angular and offset alignment measurement results for two measurement planes; the plane through measurement positions 1 and 3 (Plane 1), and the plane through measurement position 2 and the position where no measurement was taken (Plane 2).

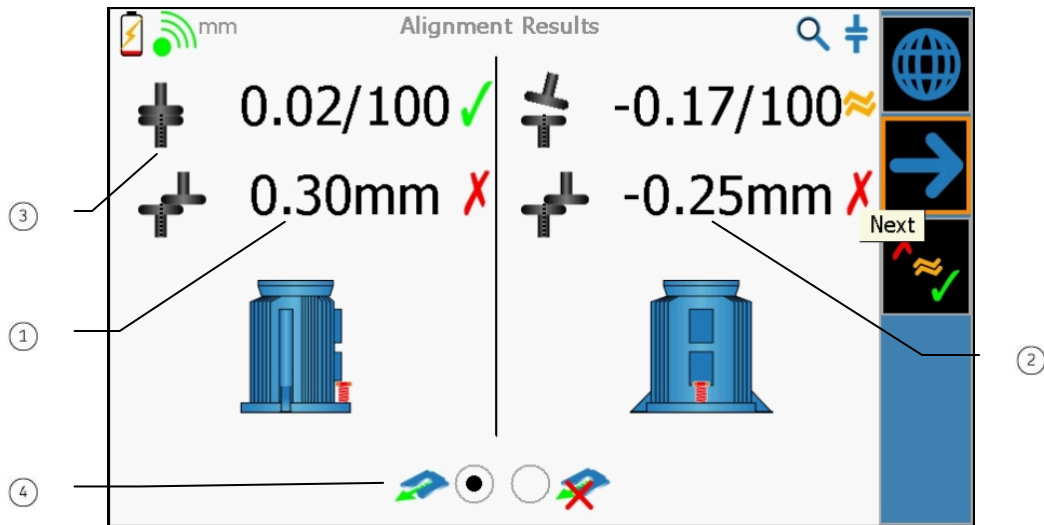



Figure 5 - 32. The **Alignment Results** Screen.

- ① shaft alignment in the plane through measurement positions 1 and 3 – Plane 1
- ② shaft alignment in the plane through measurement position 2 and the position where no measurement was taken – Plane 2
- ③ coupling position icon
- ④ correction / no correction icons

For each measurement plane, angular and offset alignment results display graphically with a coupling position icon that shows the coupling's current position as viewed from the respective plane; and numerically in the specified units of measurement. Measurement results with respect to alignment tolerances display as:

- ✓ When measurement results are within the specified tolerance.
- ≈ When measurement results are between 1x and 2x the specified tolerance.
- ✗ When measurement results are more than twice the specified tolerance.

Based upon vertical and horizontal alignment results, choose whether to correct the machinery alignment or to leave it as-found:

-  Select the "correction" icon if you wish to correct the machinery alignment (default setting if tolerances are exceeded), or
-  Select the "no correction" icon to leave the machinery alignment as-found (default setting if tolerances are not exceeded). Then press the right panel's Next Screen icon to progress to the next inspection's results.

How to Correct As-Found Conditions and Verify Corrections (Vertical)

Alignment Corrections (Vertical)

The **Dimensions** screen displays again to allow entering any of the optional dimensions that were not entered in the initial setup.

The **Alignment Corrections** screen displays alignment correction information for machinery alignment movements. **Alignment Corrections** screens are “live” displays that automatically update their displayed angular and offset alignment results and their alignment correction information as you move the machine, to show how your machine “moves” are affecting shaft alignment in real time.

- You must position the measuring units to either the measurement 1 position (original reference bolt) or the measurement 2 position (90 degrees from the original reference bolt) to view live measurement values as you move the machine.

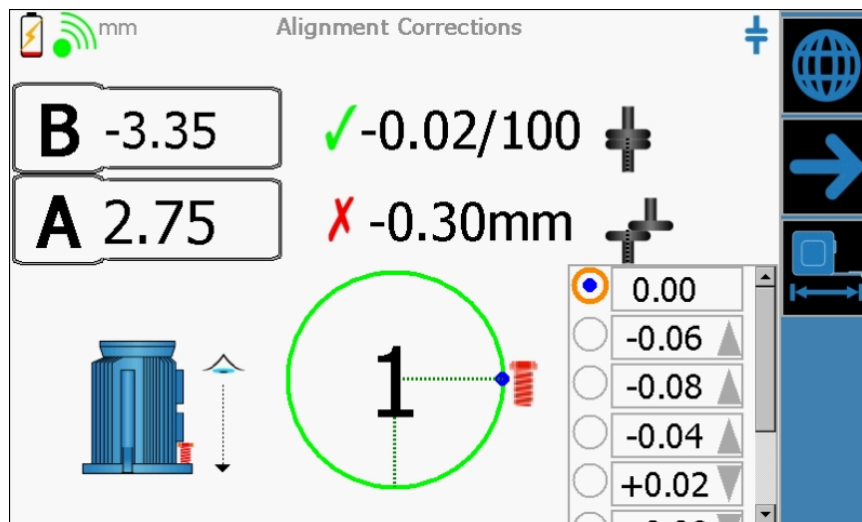
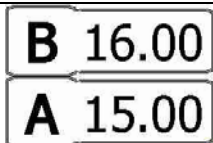
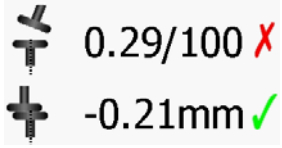
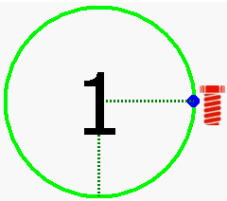
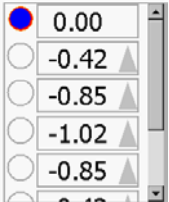



Figure 5 - 33. An Example Vertical **Alignment Corrections** Screen.

The angular and offset results coupling icons display a graphical representation of how the coupling is currently aligned when viewed from a specific measurement plane (If the measuring units are at Position 1, the misalignment is representative of viewing from Position 2 (the default) - If the heads are at Position 2, the misalignment displayed is from Position 3 (i.e., +90 degrees from the measuring units), the alignment results icons indicate that the current angular and offset alignment results are more than twice the specified tolerances (red X), and the bolt shim list shows shim adjustments for the eight flange bolts (when the reference bolt is selected).

Angular misalignment is corrected by shimming the bolts as described in the bolt shim list. Parallel misalignment is corrected by moving the flange in the same plane as the moveable measuring unit.

The vertical **Alignment Corrections** screen's information and right panel menu icons are overviewed in the following table.

Icon / Menu	Description
	Displays the A and B measuring units' current displacement.
	Angular and offset alignment results for the displayed plane. Coupling icons display a graphic representation of the current alignment condition. Alignment results icons indicate alignment results compared to specified tolerances.
	Flange reference bolt indicator. Number and small dot on circle indicate which flange bolt is selected as the reference bolt in the bolt shim list. The red bolt icon indicates the initial measurement reference bolt. In our example, the initial measurement reference bolt remains the selected reference bolt in the bolt shim list. All other bolts are numbered (clockwise) from the initial measurement reference bolt.
	Bolt shim list. Shows the amount and direction of misalignment for each flange bolt (with respect to the selected reference bolt). Positive values and downward pointing arrows indicate that you need to remove bolt shims; negative values and upward pointing arrows indicate that you need to add shims.
	After making corrections, select the right panel's Next Screen icon to: - If no other inspection corrections were specified, progress to the Measurement screen, allowing you to re-perform your alignment measurements, to verify the results of your corrections. - If other inspection corrections were specified, progress to the measurement screen for those inspections requiring correction.
	If necessary, select to return to the Dimensions screen (e.g., if you need to check or correct the entered dimensions).

To correct the vertical misalignment:

- You must position the measuring units to either the measurement 1 position (original reference bolt) or the measurement 2 position (90 degrees from the original reference bolt) to view live measurement values as you move the machine.
- If necessary, select a different bolt to be your reference bolt (e.g., if one of the other bolts cannot be loosened to make the required shim adjustments, you may wish to make that bolt your reference bolt). The flange reference bolt indicator graphic and the shim values for all other bolts in the bolt shim list adjust for the new reference bolt.

- To correct the angular misalignment, add or remove shims to each flange bolt as detailed in the bolt shim list.
- To correct the offset misalignment, move the moveable machine by the specified distance (1.25 mm in our example). The moveable machine should be moved in the direction at which the measuring units are positioned (i.e., if the measuring units are at position 1, the moveable machine should be moved in a straight line though positions 1 & 3; if the measuring units are at position 2, the moveable machine should be moved through position 2 and the non-measured position).

As you move the machine, the angular and offset alignment results update to show the results of your movements.

- After all alignment values are within tolerances, select the right panel's Next Screen icon to progress to the alignment **Measurement** screen, where you measure and record the as-corrected alignment. This allows you to verify that your alignment is still within tolerances after all machinery corrections have been finalized.
- After recording the as-corrected alignment measurements, press the right panel's Next Screen icon, the **Alignment Results** screen displays, showing alignment results after correction.
- After reviewing the as-corrected alignment results, press the right panel's Next Screen icon to view the **Job Save** screen.

How to Save the Alignment Job

Whenever you select to leave the alignment job process (e.g., at the end of the job or by selecting Home from the Global Functions menu), you are prompted to save your alignment job. If you select **Yes** at the prompt, the **Save Job** screen displays.

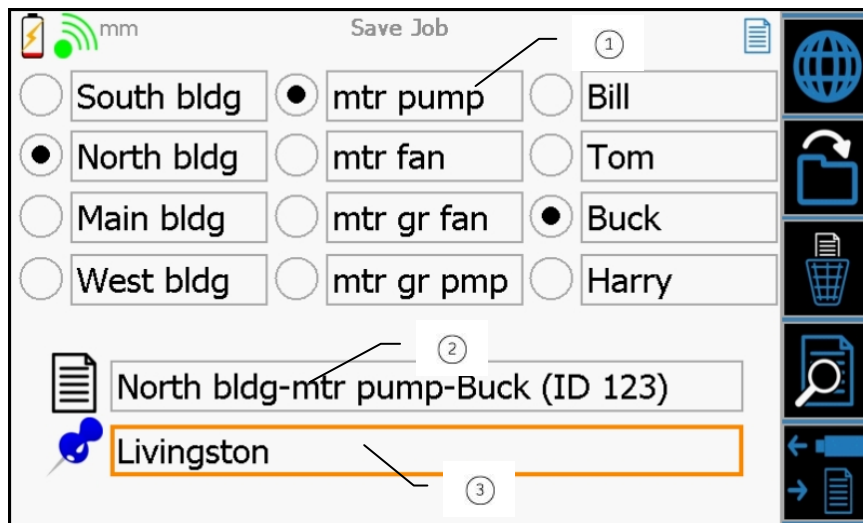







Figure 5 - 34. An Example **Save Job** Screen.

- ① reference fields and selection buttons
- ② job name field

③ job location field

The twelve alpha/numeric data entry fields at the top of the screen (each associated with a selection button) allow you to enter up to twelve references that help identify useful information about your alignment jobs. References entered in these twelve fields display whenever you save an alignment job. When you then save an alignment job, you may select one reference from each column (using the associated selection buttons) to insert (at the cursor location) in the alignment job's name. This allows you to quickly and consistently name your alignment jobs.

To save your alignment job:

-  In the job name field, enter the alignment job's name – or – using the twelve selection buttons, select to insert a reference from each column to include in the alignment job's name and, if desired, then select the job name box to enter additional job name text (e.g., the asset's ID).
 - The job's date is automatically appended to the entered job name in the Job Report.
-  (optional) In the Job Location field, enter the job location. For example, if alignment jobs are performed at various facilities, enter the facility's name as the job location. In the future, when you recall previously saved jobs from the TKSA 60 / 80 database, filtering by location facilitates faster recall.
-  In the right panel menu, select the Save icon, the alignment job is saved and you are returned to the Home screen.
-  In the right panel menu, select the Review icon to view the Job Report on the display unit.
-  In the right panel menu, select the To USB icon to export the job report to a USB memory stick in .pdf format for transfer to PC.
 -  You may select the right panel's Discard icon to discard the current job without saving it.

The Alignment Job Report

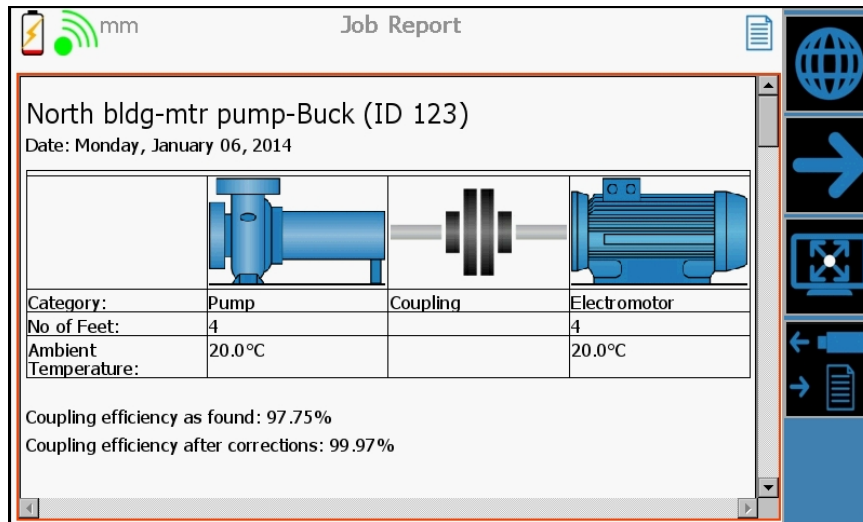



Figure 5 - 35. An Example **Job Report** Summary Screen.

The **Job Report** screen shows a summary report for the alignment job. The displayed **Job Report** includes the date and time of the job, coupling efficiency ratings for both as found and after correction, the job's machine train information, specified tolerances and targets, machine dimensions, and alignment and inspection results (both as found and after correction).

To view specific alignment or inspection results screens:

- Use the up and down arrows on the keypad to scroll through the report, or hold down the up/down arrows to continuously scroll. Use the left/right arrows to page up/page down through the report. The **Job Report** screen shows both as found and after correction results.









-  Press the Full Screen icon to display the report in full screen view. To exit full screen view, press the keypad's **OK** button. You will return to the **Job Report** screen.

-  Select the To USB icon to export the Job Report in .pdf format to a USB memory stick for transfer to PC.

After reviewing the Job Report, select the right panel's Next Screen icon to progress to the next screen.

Inspections

Inspection options are overviewed in the following table and then discussed in detail.

Icon	Description
	Check machine foundation status
	Check bolt / washer status
	Check for general machine and coupling wear
	Check for oil leaks
	Check oil levels
	Inspect current shim arrangements
	Check torque for foundation bolts
	Check for shaft runout
	Test for soft foot conditions

In this manual's previous quick alignment example, we detailed use of the shaft runout, soft foot, and shims inspections. All other inspections are detailed below.



Machine Foundation Inspection

Visual inspections (e.g., machine foundation status, oil leak status, etc.) are recorded using a "traffic light" type indicator.

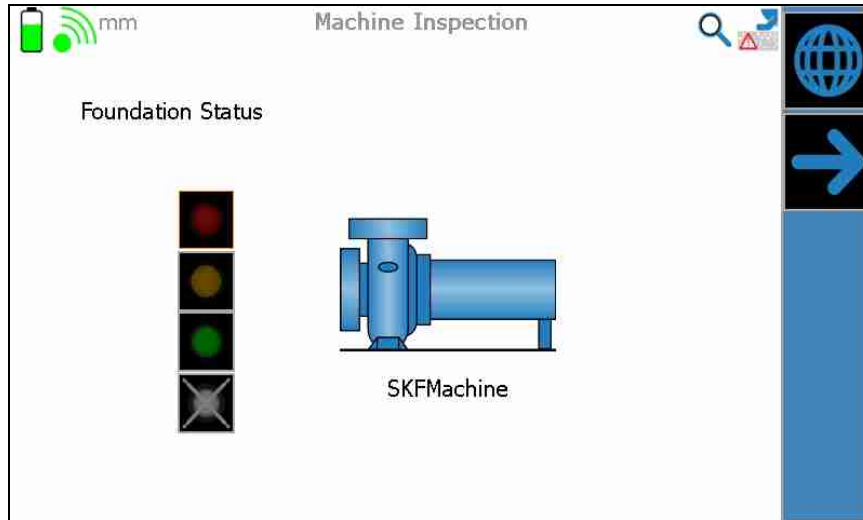

Figure 5 - 36. The **Machine Foundation Inspection** Screen.

During the inspection, the above screen displays for both machines in the machine train, allowing you to perform the inspection for both machines.

To perform a machine foundation inspection:

- For the machine indicated on the **Machine Inspection** screen, inspect the machine's foundation for faults.
- Use the screen's traffic light indicators to select:
 - The green light to indicate "condition is good."
 - The yellow light to indicate "condition is suspect."
 - The red light to indicate "condition is bad."



If desired, you may select the "clear selection" icon to clear the selection for this inspection.

- After recording the condition for the first machine in the machine train, select the right panel's Next Screen icon and repeat the procedure for the other machine.
- After recording the condition for both machines in the machine train, select the right panel's Next Screen icon. The **Select Inspection** screen re-displays, allowing you to select another inspection.
 - Since you've now performed the inspection, its icon no longer displays on the **Select Inspection** screen.

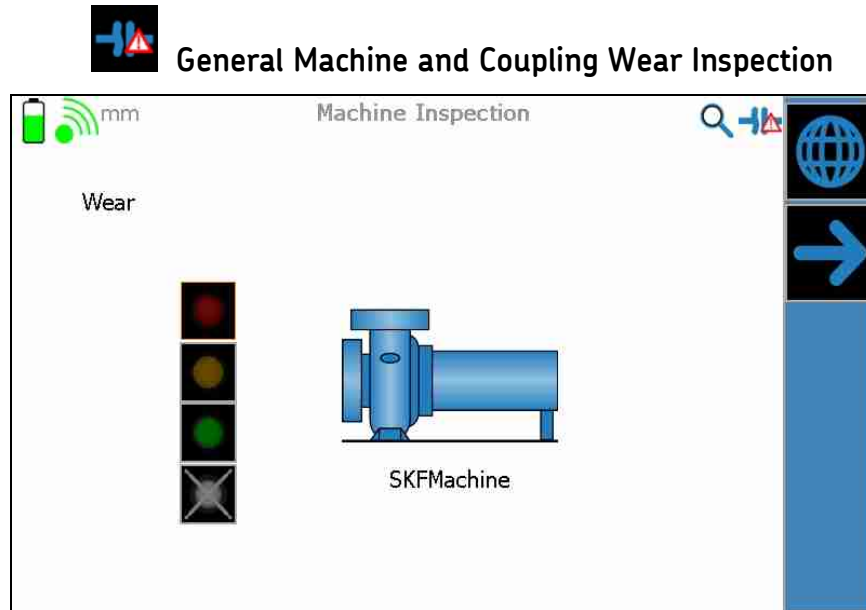

Figure 5 - 37. The **Machine Wear Inspection** Screen.

During the inspection, the above screen displays for both machines and the coupling in the machine train, allowing you to perform the inspection for both machines.

To perform a general machine and coupling wear inspection:

- For the machine indicated on the **Machine Inspection** screen, inspect the machine for general wear.
- Use the screen's traffic light indicators to select:
 - The green light to indicate "condition is good."
 - The yellow light to indicate "condition is suspect."
 - The red light to indicate "condition is bad."



If desired, you may select the "clear selection" icon to clear the selection for this inspection.

- After recording the condition for the first machine in the machine train, select the right panel's Next Screen icon and repeat the procedure for the coupling, and for the other machine.
- After recording the condition for both machines and the coupling, select the right panel's Next Screen icon. The **Select Inspection** screen re-displays, allowing you to select another inspection.
 - Since you've now performed the inspection, its icon no longer displays on the **Select Inspection** screen.

Washer / Bolt Inspection

The **Washer Bolt Inspection** screen allows you to either:

- Specify washer and bolt conditions for each for of the machine individually, or
- Specify washer and bolt conditions for all machine feet.

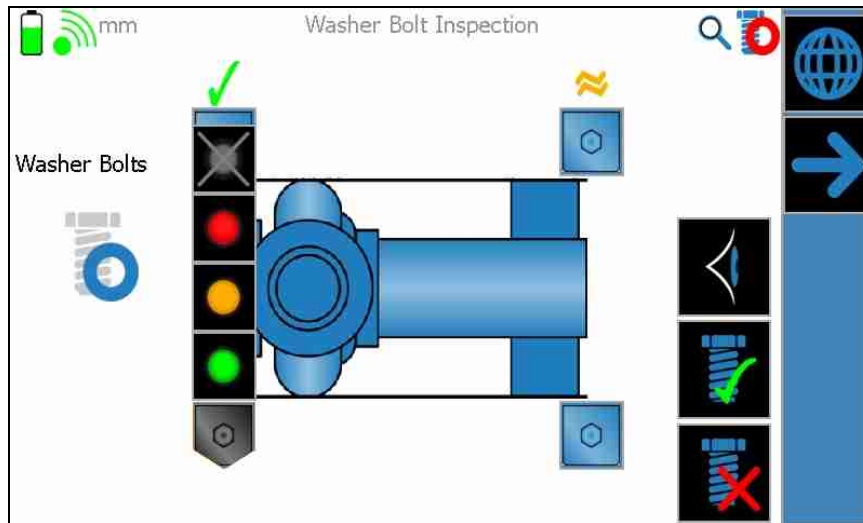

Figure 5 - 38. The **Washer Bolt Inspection** Screen Showing an Individual Foot Entry.

During the inspection, the above screen displays for both machines in the machine train, allowing you to perform the inspection for both machines.

To perform a washer / bolt inspection:

- For the machine indicated on the screen, select one of the machine feet. The selected foot's traffic light indicator displays.
- Inspect the selected machine foot's washer and bolt for damage, corrosion, imperfections, etc. and use the traffic light indicators to specify the selected foot's washer / bolt condition:

The green light to indicate "condition is good."



The yellow light to indicate "condition is suspect."

The red light to indicate "condition is bad."

- Repeat for the other machine feet.

Or,

- Inspect all washers and bolts for the displayed machine.

-   Select either the "all good" or "all bad" icon to indicate all washer / bolt conditions.

- After recording the condition for the first machine in the machine train, select the right panel's Next Screen icon and repeat the procedure for the other machine.
- After recording the condition for both machines in the machine train, select the right panel's Next Screen icon. The **Select Inspection** screen re-displays, allowing you to select another inspection.
 - Since you've now performed the inspection, its icon no longer displays on the **Select Inspection** screen.



Bolt Torque Inspection

The Bolt Torque Inspection allows you to verify the amount of torque for each bolt on the machine train.

The **Bolt Torque Inspection** screen allows you to either:

- Record bolt torque conditions for each of the machine individually, or
- Record bolt torque conditions for all the machine's feet.

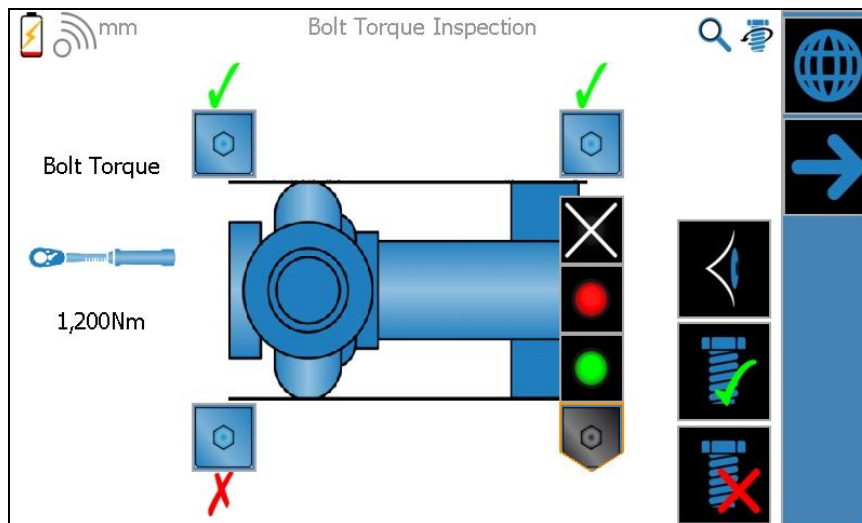

Figure 5 - 39. The **Bolt Torque Inspection** Screen.

During the inspection, the above screen displays for both machines in the machine train, allowing you to perform the inspection for both machines.

The machine's foundation bolt torque is displayed. Use it as the reference when inspecting/correcting.

To perform a bolt torque inspection:

- For the machine indicated on the screen, select one of the machine feet. The selected foot's traffic light indicator displays.
- Inspect the selected machine foot's bolt torque and use the traffic light indicators to specify the selected foot's bolt torque condition:

The green light to indicate "condition is good."

The red light to indicate "condition is bad."

- Repeat for the other machine feet.

Or,

- Inspect bolt torque for all machine feet for the displayed machine.



- Select either the "all good" or "all bad" icon to indicate all bolt torque conditions.
- After recording the condition for the first machine in the machine train, select the right panel's Next Screen icon and repeat the procedure for the other machine.
- After recording the condition for both machines in the machine train, select the right panel's Next Screen icon. The **Select Inspection** screen re-displays, allowing you to select another inspection.
 - Since you've now performed the inspection, its icon no longer displays on the **Select Inspection** screen.

All remaining inspections operate in a similar manner.

How to Set Up and Perform Full Alignment Jobs

Overview

In chapter five, we discussed how to perform Quick Alignment jobs. Now we will discuss how the TKSA 60 / 80 Alignment Tools perform a full alignment job. In general, the process for performing a full alignment is similar to that for performing a Quick Alignment (i.e., job setup – perform initial as-found measurements – view results and determine if corrections are necessary – make corrections and record as-corrected conditions). However, with full alignments:

- We can specify alignment inspections on machine trains other than motor / pump machine trains, including machine trains consisting of more than two machines.
- We make use of machine train templates to help structure the alignment process. These machine train templates are provided for most of the common machinery setups in factories and plants, and allow you to store and reuse exact setup information for your machine trains. These templates are a powerful tool for consistent precision alignment of your machinery over the long term.
- More setup occurs at the beginning of the job. You determine which inspections will be performed at the start of the job setup by selecting from the list of available inspections for the selected machine train.
- The alignment process is performed in a more structured manner. The order in which alignment and other selected inspections are carried out is fixed in such a way as to facilitate the most effective alignment process.

To start a full alignment job:

-  From the Home screen, select the **New Job** icon. The **Train Setup** screen displays, allowing you to specify the type of machine train you are aligning.

Machine Train Setup

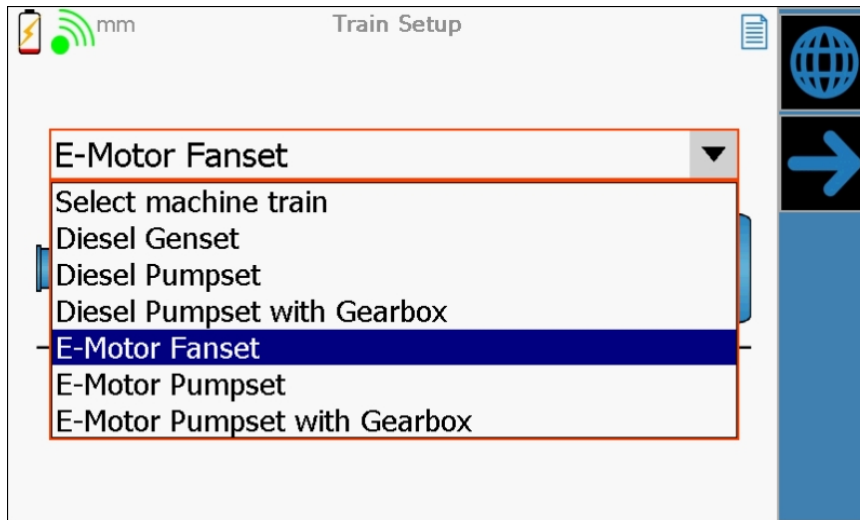

Figure 6 - 1. The Machine **Train Setup** Selection Screen.

- Using the **Select machine train** drop down list, select the machine train that corresponds to the machine train that you are aligning. Machine trains containing 2, 3 or up to 5 machines (if multi-machine support is licensed) are identified in the list. A graphic illustrating the currently selected machine train is displayed.

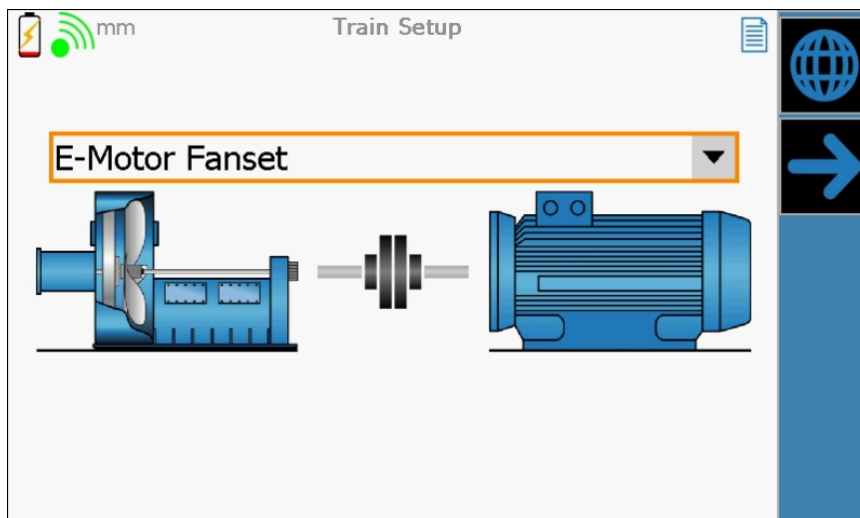

Figure 6 - 2. The **Train Setup** Screen Showing the Selected Machine Train.

- Depending on your machine train choice, some inspections may, or may not be applicable. For example, the oil level inspection is only applicable for machines that include a sump (e.g., diesel engine or gear box).
- Select the right panel's Next Screen icon to continue. The **Setup Inspections** screen displays, allowing you to specify which inspections to perform as part of the alignment job.

Inspections Setup

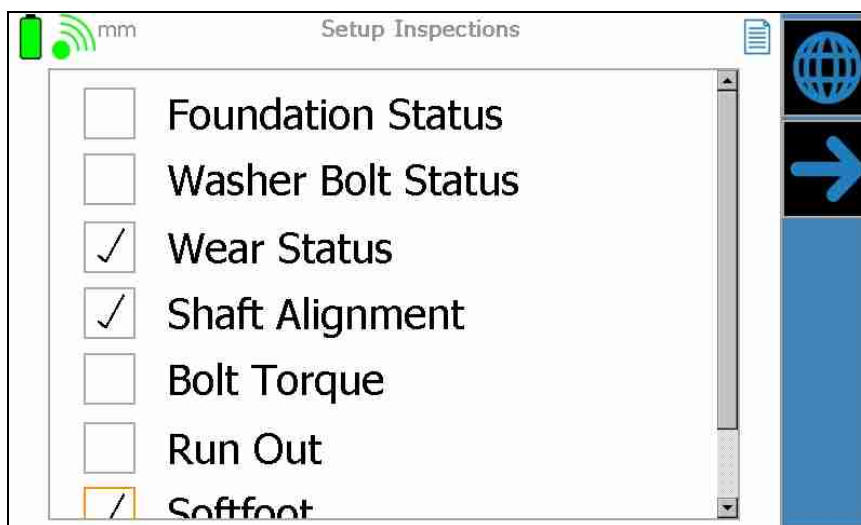

Figure 6 - 3. The **Setup Inspections** Screen.

The **Setup Inspections** screen displays all available inspections that may be included as part of your full alignment job. The inspections are listed in the sequence in which they are executed by the TKSA 60 / 80 full alignment process.

The order for initial inspections is as follows:

Foundation status

Washer / bolt status

Wear status

Oil leaks

Oil level

Shaft alignment - should always be inspected as-found, before any bolts are loosened on the machine

Bolt torque – again, should be inspected as-found before loosening any bolts

Run out

Soft foot

Chocking height

- From the displayed list, select the inspections you wish to perform as part of the full alignment job. A checkmark displays next to selected inspections.
- After selecting all required inspections, select the right panel's Next Screen icon to continue. The **Chocking Setup** screen displays.

Shims / Chocking Setup

The **Chocking Setup** screen allows you to specify whether shims or chocks are used for the machinery being aligned, and the length and width dimensions of the shims / chocks used for each machine in the machine train. This allows you to gather the correct shims / chocks prior to going onsite to perform the alignment.

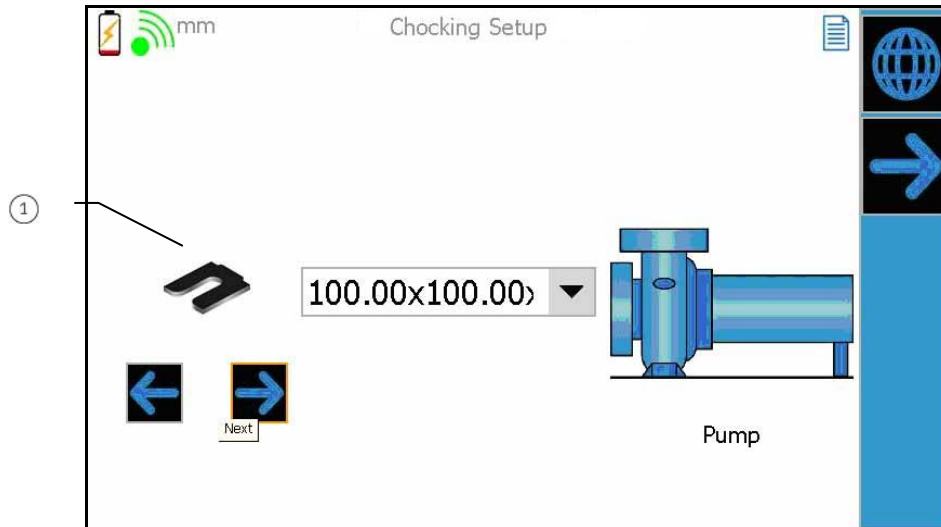



Figure 6 - 4. The **Chocking Setup** Screen.

① shim / chock icon

The above screen displays for all machines in the selected machine train, allowing you to specify the shim / chocking setup for all machines.

-   For the displayed machine, use the Previous and Next icons to specify that the machine is using either shims or chocks. The shim / chock icon updates to indicate your choice.
- Use the drop down list to specify the length and width dimensions for the shims / chocks being used for the displayed machine.
- After specifying the setup for the first machine in the machine train, select the right panel's Next Screen icon and repeat the procedure for the other machine(s) in the machine train.
- After specifying information for all machines in the machine train, select the right panel's Next Screen icon. The **Bolt Setup** screen displays.

Bolt Setup

Each machine is secured with foundation bolts. There are a few elements that are important for this securing function. The first is that the bolts are not bent, corroded, damaged, or burred before using them to secure the machine. The second is the force that is applied to the bolt to secure the machine to its foundation. The TKSA 60 / 80 provides a method to specify the details of the foundation bolts (material grade and dimensions), the lubricant that is applied for thread connection and mating surfaces of the nut and bolt head (Oil or MoS2) and a field to enter the desired torque force (at desk calculated Moment).

- The TKSA 80 provides the possibility to either enter the Moment manually or calculate the Moment for the user automatically (based on the variables entered such as grade, dimensions and lubricant/additive).

The **Bolt Setup** screen allows you to specify the type of foundation bolts that secure the machine, the torque setting for the bolts, and the type of additive to use.

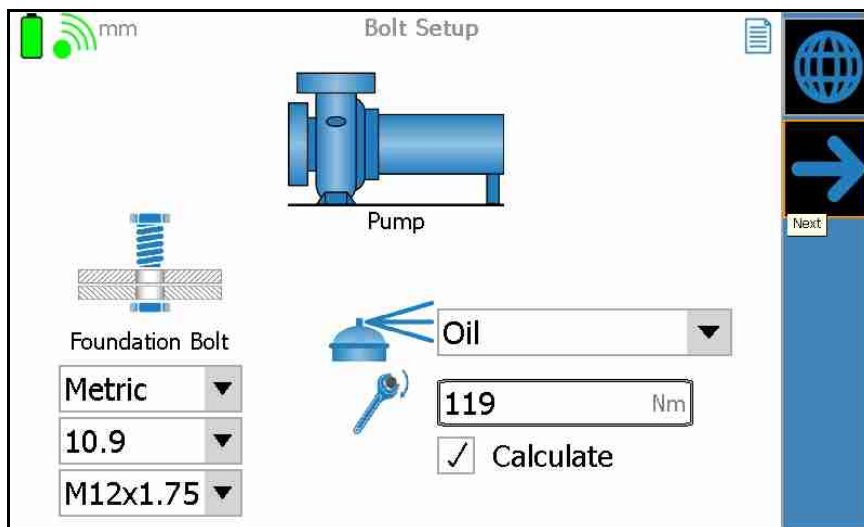
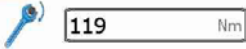

Figure 6 - 5. The **Bolt Setup** Screen.

The above screen displays for all machines in the selected machine train, allowing you to specify bolt setup information for all machines.

Bolt Setup fields are detailed in the following table.

Icon / Menu	Description
Metric	Specify the type of foundation bolts used (Metric or UTS).
10.9	Specify foundation bolt grade.
M12x1.75	Specify foundation bolt size.
Oil	Specify lubricant used on foundation bolts (Oil or Molykote MoS2).

Icon / Menu	Description
	Specify the foundation bolt torque setting. Enter the value in the numeric entry box - or - (TKSA 80 only) enable the Calculate check box to have the application automatically calculate the torque setting.

- After specifying the setup for the first machine in the machine train, select the right panel's Next Screen icon and repeat the procedure for the other machine(s) in the machine train.
- After specifying information for all machines in the machine train, select the right panel's Next Screen icon. The alignment **Target Setup** screen displays.

Alignment Target Setup

Default alignment targets are 0, 0, which indicate perfectly aligned shafts. The **Target Setup** screen allows you to enter alignment targets other than 0, 0 for each shaft in the machine train. This is typically done to adjust for a cold alignment to allow for thermal growth factor, or for alignment conditions where mechanical expansion is a consideration.

- Alignment targets are optional and can be omitted, in which case alignment targets default to 0.

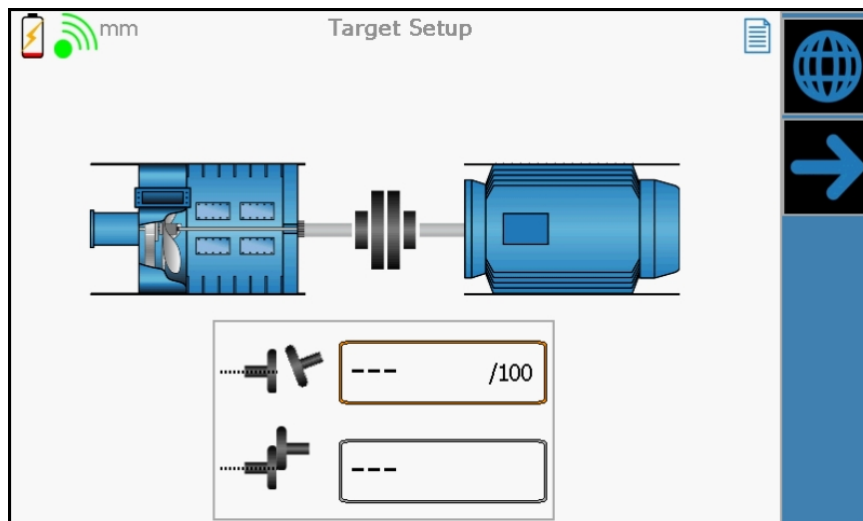

Figure 6 - 6. The Horizontal Alignment **Target Setup** Screen.

The above screen displays for all shafts in the selected machine train, allowing you to specify alignment targets for all machine train shafts.

- If required, for the displayed machines, enter both the offset and angular horizontal alignment targets.
 - If required, consult the manufacturer's machinery data sheets to determine the alignment targets.
- Select the right panel's Next Screen icon to continue. The vertical alignment **Target Setup** screen displays.

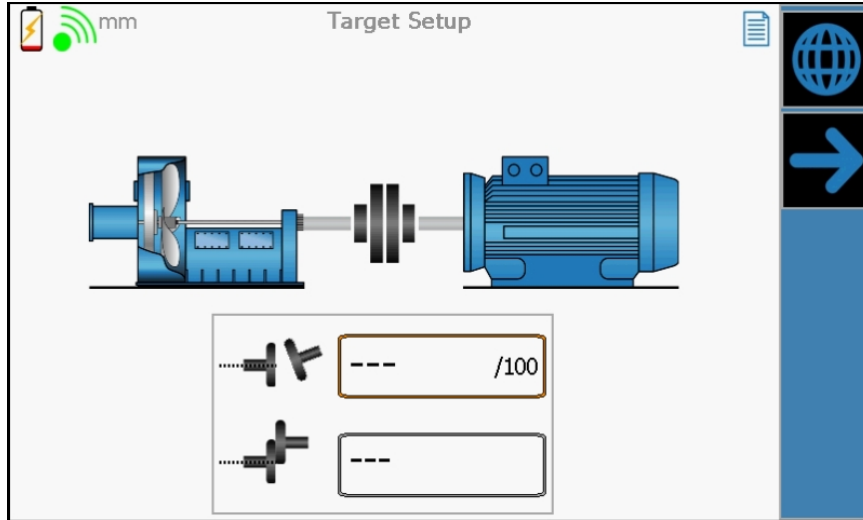

Figure 6 - 7. The Vertical Alignment **Target Setup** Screen.

- If required, for the displayed machines, enter both the offset and angular vertical alignment targets.
- After specifying the horizontal and vertical alignment targets for the first set of shafts in the machine train, select the right panel's Next Screen icon and repeat the procedure for the other shaft(s) in the machine train, if necessary.
- After specifying alignment target information for all shafts in the machine train, select the right panel's Next Screen icon. The **Alignment Tolerances** screen displays.

Alignment Tolerances

On the **Alignment Tolerances** screen, specify alignment target tolerances for the displayed shafts (i.e., how close you must get to the specified horizontal and vertical alignment targets).

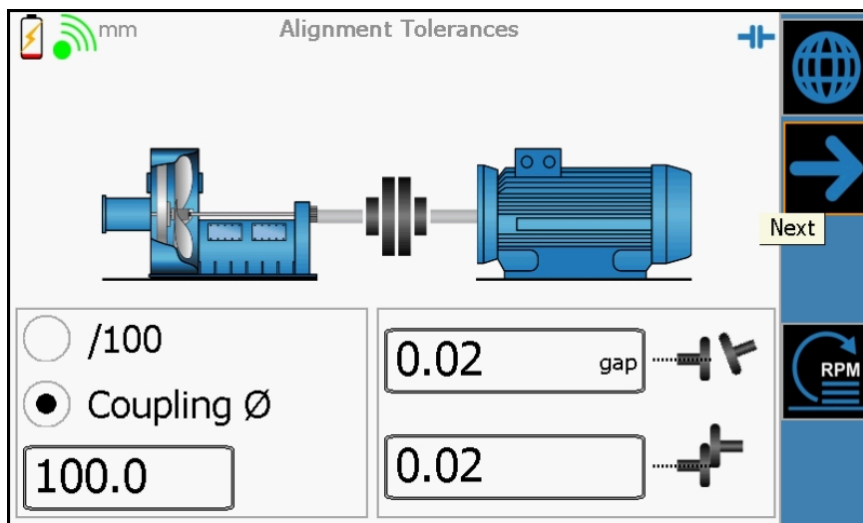
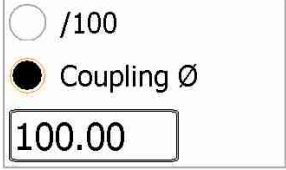
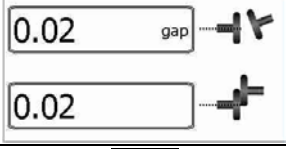



Figure 6 - 8. The **Alignment Tolerances** Screen.

The above screen displays for all shafts in the selected machine train, allowing you to specify alignment tolerances for all machine train shafts.

Alignment tolerance options are overviewed in the following table.

Icon / Menu	Description
	<p>Specify whether to measure angular misalignment relative to a fixed distance or as a proportion of the coupling diameter (Coupling Ø).</p> <p>If /100 is selected, enter tolerances using units specified in the units of measurement Settings screen (for Metric units - mm / 100 mm); for English units mil/in or mil/ft. If Coupling Ø is selected, an additional numeric entry field displays, allowing you to enter the coupling diameter in the specified length units.</p>
	<p>Enter the angular tolerance for the displayed shafts.</p> <p>Enter the offset tolerance for the displayed shafts.</p>
	<p>Provides access to a tolerance table based on machine RPM.</p>

- First, select whether to measure angular misalignment relative to a fixed distance (e.g., mm / 100 mm or mil / 1 in) or as a proportion of the coupling diameter (i.e., measure angular misalignment as coupling gap).
- Next, enter the angular and offset tolerances for the displayed shafts or press the tolerance table icon to select the tolerances from a predefined table of tolerances based on machine RPM.

During the alignment job:

- ✓ When measurement results are within the specified tolerance, they are displayed with a green check mark.
- ≈ When measurement results are between 1x and 2x the specified tolerance, they are displayed with an amber wavy-lines mark.
- ✗ When measurement results are more than twice the specified tolerance, they are displayed with a red cross.
- Select the right panel's Next Screen icon to continue. If there are more than two machines in the machine train, the next coupling's **Alignment Tolerances** screen displays. Repeat for all couplings in the machine train.
- After entering all coupling alignment tolerances, select the right panel's Next Screen icon to continue. The **Tools Setup** screen displays.

Tools Setup

If you have a lot of machine setups in your factory / plant, it is unlikely that you remember every specific tool you need for each individual machine. The **Tools Setup** feature allows you to specify which tools you need for a specific machine setup. This allows you to gather the required tools before going onsite to the job location.

The specified tool list is displayed during job setup. When you clone a job (reference **Chapter 7, Working with the Jobs Database / How to Work with Previously Saved Jobs**), you are provided the cloned job's tool list as you verify the new job's setup, allowing you to view the tools required for the previously executed job (the cloned job).

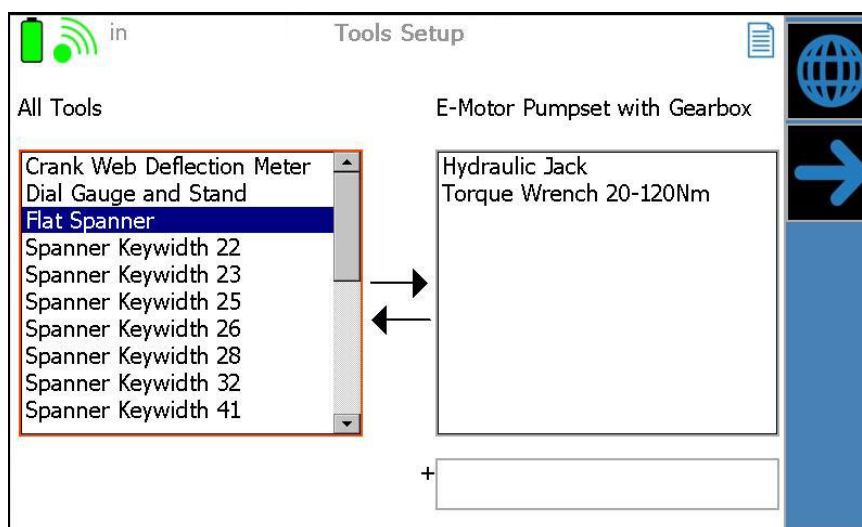

Figure 6 - 9. The **Tools Setup** Screen.

On the left of the screen, the **All Tools** list displays all the tools in alphabetic order from which you may select specific tools required for your job.

To select tools required for the alignment job:

Keypad method

- Use the arrow keys to move the cursor to the **All Tools** list (blinking indicator)
- Press **OK** to select the **All Tools** list (solid indicator)
- Press the down arrow to move the highlighter down the list until the desired tool is highlighted.
- Press the right arrow to move the highlighted tool to the job's machine train list (e.g., from the **All Tools** list) Press the left arrow to remove the highlighted tool from the machine train list.
 - If necessary, press the **C** keypad button to unselect the currently selected list.

Touch screen method

- In the **All Tools** list, tap the tool you wish to select, the tool highlights.
- Tap the job's machine train list, the highlighted tool moves to the job's list.
 - If necessary, press the **C** keypad button to unselect the currently selected list.

To add a tool that is not on the All Tools list to the machine train list:

- Select the **+** entry field at the screen's bottom right. (TKSA 80 only, the alpha/numeric keypad displays.)
- Enter the tool's name and press **OK**. The tool's name appears in your job's machine train list.
 - You may move the new tool to the **All Tools** list to make it permanently available from the **All Tools** list for future jobs.

At this point, you are finished setting up the **New Job** and have two options:

- If you wish to immediately proceed with the job, select the right panel's Next Screen icon to proceed with the alignment job. Apply each alignment job screen as previously described in **Chapter 5, How to Perform a Quick Alignment**.

Or,

- If you wish to save the **New Job**'s settings so you may perform the job at a later time, select the right panel's Global Functions icon, and then the Home icon. You are prompted whether **you wish to save the current job**. Select **Yes**, and the **Save Job** screen displays. Save the new job as previously described in **Chapter 5, How to Perform a Quick Alignment / How to Save the Alignment Job** section. In the future, the saved New Job will be available for use from the Job Database (reference **Chapter 7, Working with the Job Database**).

Working with the Job Database

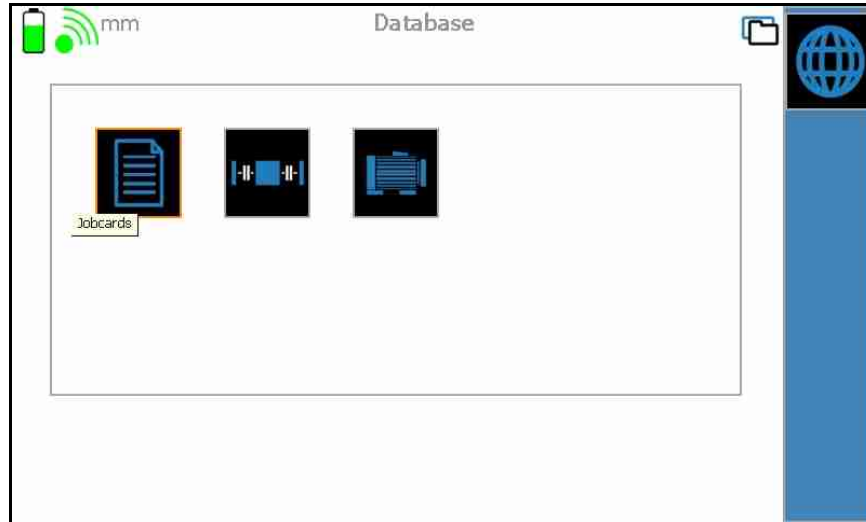

Figure 7 - 1.

Options on the **Database** screen allow you to recall previously stored jobs and reports, and to create new machine trains and new machine components for use in future alignment jobs.



Recall and review previous jobs and reports



Create a new machine train (TKSA 80 only)



Create a new machine component (TKSA 80 only)

How to Work with Previously Save Jobs

The **Database** screen's **Job Cards** option allows you to select and perform operations with previously saved jobs stored in the TKSA 60 /80's database.

To recall a saved job:

- From the Home screen, select the **Job Cards** icon. The **Job Selection** screen displays.

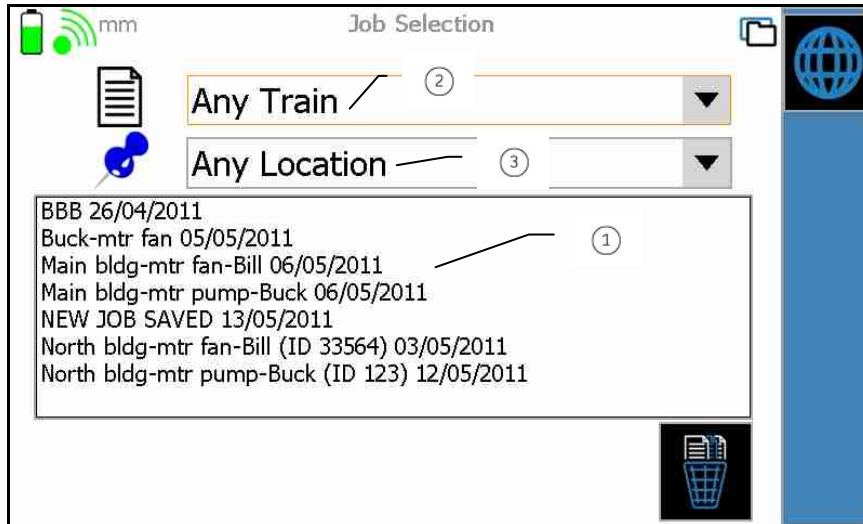



Figure 7 - 2. The **Job Selection** Screen.

Job Selection screen items are overviewed in the following table.

- ① Saved jobs list
- ② machine train filter
- ③ job location filter
-  delete all saved jobs

The initial **Job Selection** screen allows you to recall a previous saved job. Fields on the **Job Selection** screen include:

- ① Saved jobs list – Alphabetically displays a list of all previously saved jobs.



Machine train filter – Displays a list of all machine trains stored in the database. Select a machine train from the list and the saved jobs list updates to display only jobs that were performed on the selected type of machine train.



Job location filter – Displays a list of all Locations entered in the database when jobs were saved. Select a location from the list and the saved jobs list updates to display only jobs that were saved for the selected location.

- Apply the Machine train filter and the Job location filter as desired.
- Select the desired job from the jobs list. Additional icons display on the **Job Selection** screen.

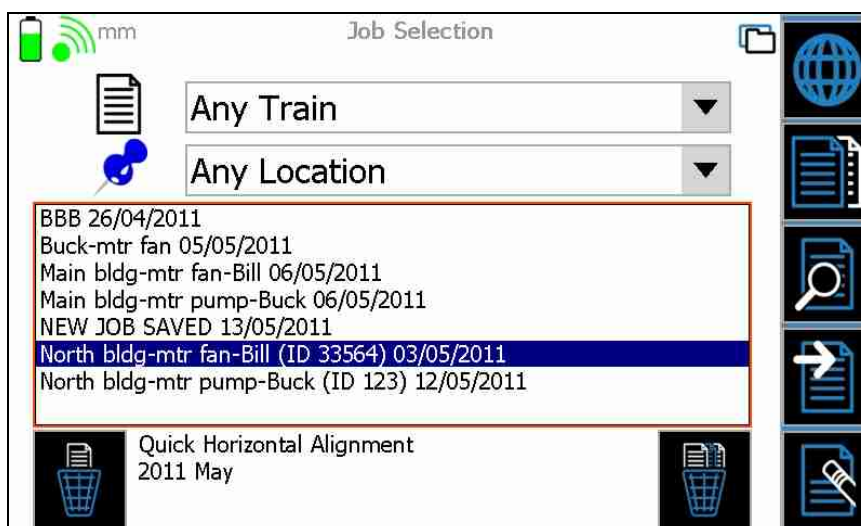









Figure 7 - 3. The **Job Selection** Screen with Additional Icons.

The four additional icons in the right panel menu allow you to proceed with the selected saved job in various ways, which are overviewed in the table below and then described in detail.

-  Clone the saved job
-  Review the saved job
-  Continue the saved job
-  Edit the saved job
-  Delete the selected job

 **Clone** – Starts a new job based upon the selected saved job's setup. All setup options for the saved job apply to the new job (i.e., machine train setup, chocking setup, inspections, targets, tolerances, etc.). When selected, brings you to the new "cloned" job's **Dimensions** screen allowing you to start the new alignment job.

 **Review** - Allows you to review the results of the selected saved job. When selected, displays the selected saved job's **Job Report** screen for your review.

 **Continue** – Displays the **Continue Job** screen for the selected saved job.

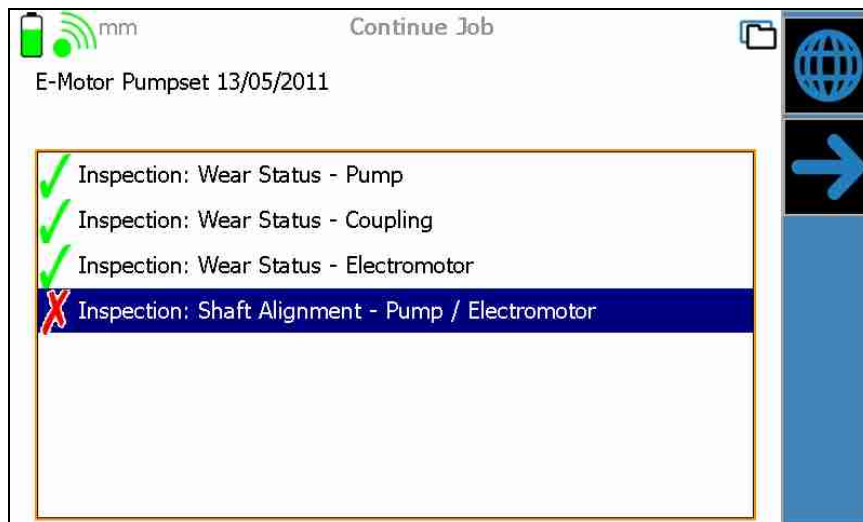

Figure 7 - 4. A **Continue Job** Screen.

The **Continue Job** list indicates steps already performed for the selected saved job with a green checkmark, and indicates the next uncompleted action with a red X.

To continue the job from where you left off:

- Select the uncompleted action with a red X from the list and select the right panel's Next Screen icon. You are returned to the step in the job process where you had left off.
- Continue with the alignment job.
 - You may also continue the saved job from a previously performed step in the process. Simply select the step at which you'd like to continue the job and press the right panel's Next Step icon. You are returned to the selected step in the process, from where you may resume the alignment job.



Edit – Allows you to edit and redo a previous job. Displays the saved job's **Dimensions** screen where you can edit the previously entered machine dimensions for the saved job, and then resume the alignment job based upon the edited dimensions.

How to Create a New Machine Train

(TKSA 80 only)



The **Database** screen's **Machine Trains** option allows you to create and store new machine trains that can then be used for future alignment jobs.

To create a new machine train:



- From the **Database** screen, select the **Machine Trains** icon. The **Create Machine Train** screen displays.

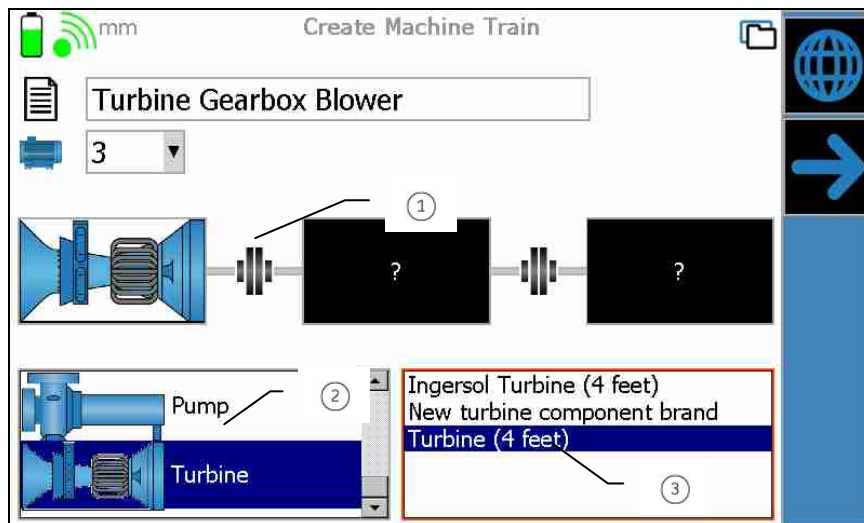

Figure 7 - 5. A Partially Populated **Create Machine Train** Screen.

Fields in the **Create Machine Train** screen include:



New machine train name



3

Number of machines in the new machine train

- new machine train graphic representation
- machine type selection list
- list of various types of the selected machine

- In the name field, enter a descriptive name for the new machine train.
- Select the drop down list and select the number of machines in the new machine train. The graphic representation updates to show the number of machines selected, and the first machine in the graphic representation starts blinking, indicating that it is the *active* machine.
- For the active machine, select the machine type selection list, then select the type of machine for the active machine in the machine train. A list showing

various types of the selected machine displays in the lower right area (i.e., if you have three types of electric motors, all three list).

- Select the lower right area, then select the specific type of machine for the active machine. The machine's graphic displays in the machine train's graphic representation and the second machine begins to blink, indicating it is the new active machine.
- Repeat the process for all machines in the machine train.
- After defining all machines for the machine train, select the right panel's Next Screen icon to continue. You are returned to the **Database** screen.

How to Create a New Machine Component

(TKSA 80 only)



The **Database** screen's **Components** option allows you to create and store new components that can then be included in new machine trains to be used for future alignment jobs.

To create a new component:

-  From the **Database** screen, select the **Components** icon. The **Create Component** screen displays.

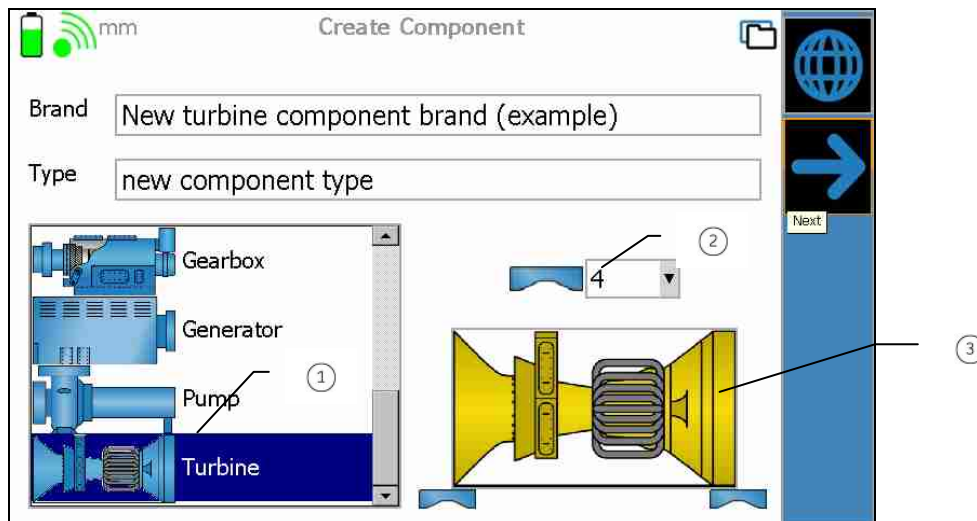

Figure 7 - 6. An Example **Create Component** Screen.

Fields in the **Create Component** screen include:

Brand - New component manufacturer

Type - Type of new component (e.g., gas motor, fan, gearbox, etc.)

① machine type selection list

② number of feet on machine (not active at this time - defaults to 4 feet only)

③ machine color selector

- In the **Brand** field, enter the manufacture of the component.
- In the **Type** field, enter the type of component.
 - After the new component is created, the specified **Brand** and **Type** display in the **Create Machine Train's** Machine Type selection list, allowing you to include the new component in the new machine train.
- Select the machine type selection list, and then select the type of machine. A graphic representation of the selected machine displays in the machine color selector area.
- Select the machine color selector graphic. A window displays various color options for the selected machine.
- Select the color for the selected machine. The machine graphic updates to display the selected color.
- After defining the new component, select the right panel's Next Screen icon to continue. You are returned to the **Database** screen.

The new component is now an available machine type when creating new machine trains.

Index

9

90 degree rule 5-8

A

about screen 2-11
additional inspections 5-12
alignment correction 5-22, 5-36
alignment results 5-19, 5-34
alignment target 5-6, 6-6
alignment tolerances 5-5, 5-29, 6-7
alpha/numeric keypad 2-4
arrow buttons 2-4

B

backlash 5-3, 5-10, 5-28
battery
 charging 2-5
 installation 2-5, 2-6
 maintenance 2-7
 measuring units 3-2
 replacement 2-6
 replacing 2-7
 status 2-10, 3-9
 temperatures 2-6
bolt - washer status 5-41, 5-44
bolt setup 6-5
bolt type 6-5
brand, machine 7-7
brightness 4-1
buttons 2-2
 arrow 2-4
 OK 2-4
 power 2-3

C

calibration date 4-3
cancel button 2-4
chain, measuring units 3-4
chocks 5-17, 6-4
clone job 7-3
connectors 2-8
continue job 7-3
correction
 additional inspections 5-27

 alignment 5-22, 5-36
 icon 5-19, 5-35
 movement 5-24, 5-37
coupling wear status 5-41, 5-43
create component 7-6
create machine train 7-5

D

database 2-10
date time settings 4-2, 4-6
dimensions 5-3, 5-16, 5-28
 stationary machine 5-16
discard, job 5-40
display unit
 battery installation 2-6
 battery status 2-5
 buttons and keypad 2-2
 connectors 2-8
 ID 4-3
 LED indicator 2-4
 overview 2-1
 settings 4-1
 stand 2-2
 touch screen 2-3

E

edit job 7-4

F

firmware version number 2-3
foundation bolts 6-5
foundation bolts, torque 5-41, 5-45
foundation status 5-41

G

global functions 2-12

H

hard reset 2-9
help 2-10
home screen 2-3, 2-9
horizontal alignment 5-2, 5-27

I

- indicator, LED 2-4
- inspection 5-41
 - additional 5-12
 - select 5-13
 - setup 6-3

J

- job
 - clone 7-3
 - continue 7-3
 - database 2-10, 7-1
 - discard 5-40
 - edit 7-4
 - location 5-39
 - name 5-38
 - recall 7-1
 - report 5-40
 - review 7-3
 - saving 5-38
 - selection 7-1

K

- keyboard 4-1
- keypad 2-2, 2-4
 - alpha/numeric 2-4
 - entering numbers/letters 2-4
 - on-screen 2-4

L

- language selection 4-1
- laser
 - CCD sensor 3-7
 - pitch adjustment 3-8
- laser soft foot 5-15
- LED indicator 2-4
 - measuring units 3-9
- location 5-39
 - filter 7-2

M

- MAC address 4-3
- machine dimensions 5-3, 5-28
- machine train
 - component 7-6
 - creating 7-5
 - filter 7-2

- selection 6-2
- setup 6-2
- machine wear status 5-41, 5-43
- measurement
 - positions 5-8, 5-31
 - recording 5-9, 5-32
 - screen 5-8, 5-24, 5-31, 5-37
 - sequence 5-8, 5-31
- measurement units 4-2
- measuring units 3-1
 - attaching 3-2
 - battery 3-2
 - battery status 3-9
 - calibration date 4-3
 - final adjustments 5-2, 5-28
 - laser 3-7
 - LED 3-9
 - pairing 4-6, 4-8
 - pairing status 4-9, 4-10
 - power button 3-9
 - prompt to move 5-11, 5-33
 - rods 3-3
 - sensor 3-7
 - settings 4-2
- menu
 - global functions 2-12
 - right panel 2-11
- moveable machine 1-4, 3-1, 5-5, 5-29

N

- name, job 5-38

O

- oil leak status 5-41
- oil level status 5-41
- OK button 2-4
- on-screen keypad 2-4

P

- pairing 4-6, 4-8
 - mode 4-6
 - status 4-9, 4-10
- pitch, laser adjustment 3-8
- positions, measurement 5-8, 5-31
- power button 2-3
- power supply 2-5

Q

quick alignment 1-6, 2-10, 5-1

R

recall job 7-1

report, job 5-40

reset

hard 2-9

soft 2-9

resume mode 2-3

review job 7-3

right panel menu 2-11

rods, measuring units 3-3

runout

inspection 5-14

results 5-20

S

safety messages 1-1

save job 5-38

screen brightness 4-1

select inspection 5-13

sensor, measuring units 3-7

settings 2-10, 4-1

alignment tolerances 5-5, 5-29

date time 4-2, 4-6

measuring units 4-2

torque 4-5

shaft runout 5-14

results 5-20

shims 6-4

inspection 5-17, 5-24

SKF title screen 2-3

soft foot 4-1, 5-15, 5-21

results 5-21

soft reset 2-9

stand 2-2

stationary machine 1-4, 3-1, 5-5, 5-29

suspend mode 2-3

system information 2-10

T

target 5-6

target setup 6-6

time zone 4-6

title screen 2-3

tolerances 6-7

icon 5-15

setting 5-5, 5-29

tommy bar 3-3

tools, setup 6-9

torque 4-5, 6-6

foundation bolts 5-41, 5-45

touch screen 2-3

calibration 4-1

keyboard 4-1

train setup 6-2

U

units of measurement 4-2, 4-5

USB connectors 2-8

user manual conventions 1-2

V

v-bracket 3-2

version number 2-3

vertical alignment 5-2, 5-27

view options 5-4, 5-5

viewing results 5-19, 5-34

W

washer - bolt status 5-41, 5-44

wireless communications 2-8

indicator 2-8

status 2-10